

Screening Theory and Practice

James F. Sullivan, P. E.



Triple/S Dynamics, Inc.

SCREENING THEORY AND PRACTICE

FOREWARD

In these few pages, the author has attempted to distill the essence of fifty-five years of experience in the design, development, manufacture and sale of bulk granular material handling and classifying equipment.

It hasn't been the same experience fifty-five times over, but rather a progressive learning experience punctuated with moments of elation or despair, the latter compensated by the occasional satisfactions of discovery.

This is an overview, not a "Handbook". It is narrowly confined to the basic principles, as understood by the author, underlying the performance, design and application of mechanical equipment for particle separation by screening. Its sources are the author's experiences, supplemented by abundant literature relative to the study of small particles. A few examples, drawn upon for this paper, are listed in the Bibliography.

James F. Sullivan
January 2013

James F. Sullivan, P. E. is the former President and Chairman, Triple/S Dynamics, Inc., (Retired). He is currently President, Professional Engineering Services, Inc. and holds a BME with Distinction from University of Minnesota, 1947. He is also a member of Tau Beta Pi, honorary engineering fraternity.

Table of Contents

1. Theory of Screening	1
2. Factors Affecting Screen Performance	3
Material Factors	3
Size and Shape	3
Density	3
Moisture	3
Size Distribution	3
Machine Factors	6
The Screening Media	6
Motion	7
Motion In The Horizontal Plane (Shaking Screens)	8
Motion In The Vertical Plane (Vibrating Screens)	9
3. The Screenability Characteristic	11
4. Estimating Screen Capacity	17
Coarse Screening Method	17
Electric Heat	20
Wet Screening	20
Fine Screening Method	21
Electric Heat	24
Wet Screening	24
Rescreening And Discontinuous Size Distributions	24
5. Fractional Efficiency	28
6. Vibration Transmission	33
Spring Suspensions	33
Cable Suspensions	34
Vibration In Steel-Framed Industrial Structures	35
7. Mechanical Design	38
Drive Mechanisms	38
Structures	40
8. Installation Planning	41
Structure	41
Clearances, Platforms and Catwalks	41
Feed to the Screen	42
Flexible Connections	42
Dust Control	43
9. Preventive Maintenance	44
Structure	44
Vibrating Mechanisms	45
Screening Media	46

Part 1. Theory of Screening

The purpose of screening is to separate from a granular substance particles that are smaller than the screen opening from those that are larger. This is not as simple as it sounds, and the difficulties compound as the opening becomes smaller. For example, if a sample of a crushed mineral ore containing 50% by weight of particles smaller than 1/8" is dropped on a static test sieve, most of the undersize will remain on the screen, with only a trickle passing through. Now if the sieve is subjected to some kind of motion, reciprocating or gyratory in the horizontal plane, or shaken with a reciprocating motion having both vertical and horizontal components, the minus 1/8" particles will begin to pass through the screen, at a diminishing rate until all but the particles closest to the opening size have been separated out. The time duration of the shaking to reach this stage will be roughly proportional to the amount of the sample placed on the test sieve¹, which determines the depth of the static material bed before the shaking starts.

The most commonly used measure of screen efficiency is the cumulative weight of material that has passed the screen in any time interval, compared to the total weight of undersize in the feed, expressed in a percentage. This can be reversed, when the oversize is the product to be recovered; then efficiency is the weight percent of material in the screened oversize fraction compared to the total weight of oversize in the feed.

The probability (p) that any particle will pass a square opening in a woven wire screen is governed by the difference between its average diameter (d) and the opening dimension (L), and the wire diameter (t). A Swedish inventor, Dr. Fredrick Mogensen, predicts the probability p of a particle passing a square mesh sieve opening, if it approaches at 90 deg. to the plane of the opening, and does not touch a boundary wire, as

$$p = K [(L-d) \div (L+t)]^2 \quad (1)$$

from which it can be seen that the probability of an undersize particle passing the opening will diminish exponentially as its diameter approaches the opening dimension, and increase exponentially as the wire diameter (t) approaches zero. It may also be noted that, if the particle is removed (d=0), the equation equals the percent open area of a square mesh wire screen ÷ 100. Thus if p is proportional to capacity, in a square mesh wire screen capacity must be proportional to the percent open area, a relationship that is made use of later in deriving the capacity correction factor F (Page 22) for the ratio L/t.

When the screen, supporting a static bed of material of extended size range, is shaken, a phenomenon called "trickle stratification"² causes the particles to stratify from finer at the bottom to coarser at the top. The shaking motion may be in the horizontal plane of the screen, circular or reciprocating, or with a vertical component, or it may be a vibration applied directly to the screen wires.³ In the example above, the particles in the fraction smaller than 1/8" that reach the screen surface have a chance of passing an opening that is expressed by the Mogensen probability function. Then ideally, for any average particle diameter less than 1/8", the number of particles of diameter d that will pass in a unit of time is the product of the probability function times the number of times a single particle is presented to an opening (without touching a boundary wire).

This ideal is confounded by unpredictable uncertainties. The necessary turbulence in the material bed caused by the motion of the screen causes interparticle interference and affects the angle at which a particle approaches an opening. The possibility for a particle to pass the opening without touching a boundary wire, a condition of the Mogensen function, is nil. Impact forces from contact with the boundary wires act as impedances to the force of gravity, the only force causing the particle to fall through the opening.

So the motion of the screen, necessary for it to work, also can have the effect of limiting its capacity, in terms of the rate of passage of undersize per unit of area. Different kinds of motion are employed in the design of screening machines, and each has its special characteristics. Most modern screening machines can be sorted into four separate categories⁴. Each is subdivided into a variety of individual differences, but the following example will assign operating parameters typical of its category.

- A. The Gyrotory Screen: 285 rpm, 2-1/2" horizontal circle dia.
- B. The Shaking Screen: 475 rpm, 1" stroke, zero pitch, 6 deg. slope.
- C. The Inclined Vibrating Screen: 1200 rpm, 1/4" vertical circle dia.
- D. The Horizontal Vibrating Screen: 840 rpm, 1/2" stroke at 45°.

Each has a .063" dia. wire screen with 1/8" clear opening, moving under a particle travelling at an assumed 20 fpm, for A, 40 fpm for B., 80 fpm for C, and 60 fpm for D. Omitting details of the calculations, the approximate number of openings presented to the particle per second is A. 200; B. 64; C. 98; D.50. The time available for the particle to fall through the opening, in sec. $\times 10^{-3}$, is A. 5.0; B. 15.6; C. 10.2; D. 20.0. If it is assumed that the probability of passage of a single undersize particle is inversely proportional to the number of openings per second passing underneath, owing to interference with the boundary wires, the relative probabilities in each case are the same as the time available. Then, on the premise stated previously that the probabilities are in direct proportion to the number of opportunities (openings) per second, the product of the two probabilities is exactly the same for each case.

The time for this theoretical particle to pass the opening, from an approach at 90° and without touching a boundary wire, is $3.3 \text{ sec} \times 10^{-4}$. The ratio of time available in each case to time required is A. 15.2; B. 47.3; C. 30.9; D. 60.6, which leads again to the same conclusion as before.

Should this oversimplified example lead to a conclusion that there is no inherent difference in relative performance among these four categories of motion?

The answer is no, because such a conclusion would be overwhelmed by the realities of differences, to name a few, in turbulence, interparticle and boundary wire interference, depth of bed, slope of screen surface, relative velocities between particle and surface, displacement normal to the surface, and acceleration patterns. The correct conclusion is that performance claims favoring any particular design, whether Category A, B, C, or D to be valid, must be based on demonstrated comparative test results.

Part 2. Factors Affecting Screen Performance

I. Material Factors

Particles in dry bulk materials are found in a variety of shapes, sizes, surfaces, densities, and moisture content. Each condition must be taken into account when attempting to predict screen performance, through its effect on capacity in terms of weight passing a given screen opening per unit area. The combined effects on screen performance, or “screenability”, of particle shape, surface texture, and surface or internal moisture, are beyond the reach of empirical solutions based only on size and density, independent of these variables. More exact information on their influence has to be gained from actual laboratory testing.

SIZE AND SHAPE

The shape of an individual granule may be angular, spherical, acicular, ovaloid, flaky, or slabby. They can be mixed in the same material, as sawdust in wood flakes. Separation cutpoint sizes in most screening applications range downward from 4” to 325 mesh (.0018”). The cutpoint defines the minimum particle size retained on the screen, and the maximum undersize particle passing. Unless the particle is acicular, platy, ovaloid or a perfect sphere, it will probably (but not necessarily) be sized by its largest dimension⁵.

DENSITY

For any given shape and size distribution, bulk density in lb./cu. ft. (PCF) for any material will be directly proportional to its specific gravity. Screening is essentially a volumetric measurement, but capacity, or the rate of passage through the screen, is typically charted in units of weight per unit time, based on a standard bulk density of 100 PCF. The actual rate for a material of different bulk density then has to be adjusted by the ratio PCF:100. Tables of bulk density for various materials can be found in most material handling publications⁶.

MOISTURE

Moisture in granular particles may be absorbed, adsorbed, or both. Either condition can impair screenability, but tolerance is much greater for internally absorbed than for external surface moisture. Surface moisture causes particles to stick together, resisting stratification. Allowable surface moisture for unimpaired dry screening of inorganic granular or pelletized particles ranges from bone dry for screen openings below 20 mesh, to 3% for 1/4” openings. Absorbed moisture in permeable soils such as ground clay can block the screen openings with cumulative buildups of extreme fines attached to the screen wires. Absorbent grains such as corn, soybeans, wheat etc. will screen freely after drying to 13-15% internal moisture. Screening of wood chips, flakes and sawdust is unimpaired up to about 30% internal moisture; however, in laboratory tests with sawdust, efficiency was reduced by almost 60% when moisture was increased to 68%.

SIZE DISTRIBUTION

The size distribution of particles in a granular bulk material is the primary characteristic that governs the rate of undersize passage through a screen opening that is larger than the smallest particle and smaller than the largest particle in a representative sample of the material. Size distribution is measured by sieve analysis, using a series of standardized

wire mesh sieves with square openings that progress, in the commonly used Tyler standard scale⁷, at the fixed rate of $\sqrt{2}$ from 1.05" to .0029" (200 mesh). The size distribution is expressed as the weight percent of each fraction between successive sieves in a series. If the weight is plotted on the y-axis against the mean size of each fraction on the x-axis, the result will resemble a frequency distribution curve.

A more useful graphic form is the logarithmic probability grid, using a two- or three-cycle log scale as the ordinate and the probability scale as the abscissa. Tyler Standard Screen openings are spaced equally on the log scale (y-axis), and the cumulative weight percent retained (or passing) on the probability scale (x-axis). The expansion of the probability scales outward from the mean emphasizes the extremes of the particle size distribution. Prints of this grid, shown in Fig. 1, can be obtained from the Internet. Fig. 2 is a sieve analysis of a sample of comminuted limestone plotted on this grid, using the ordinate

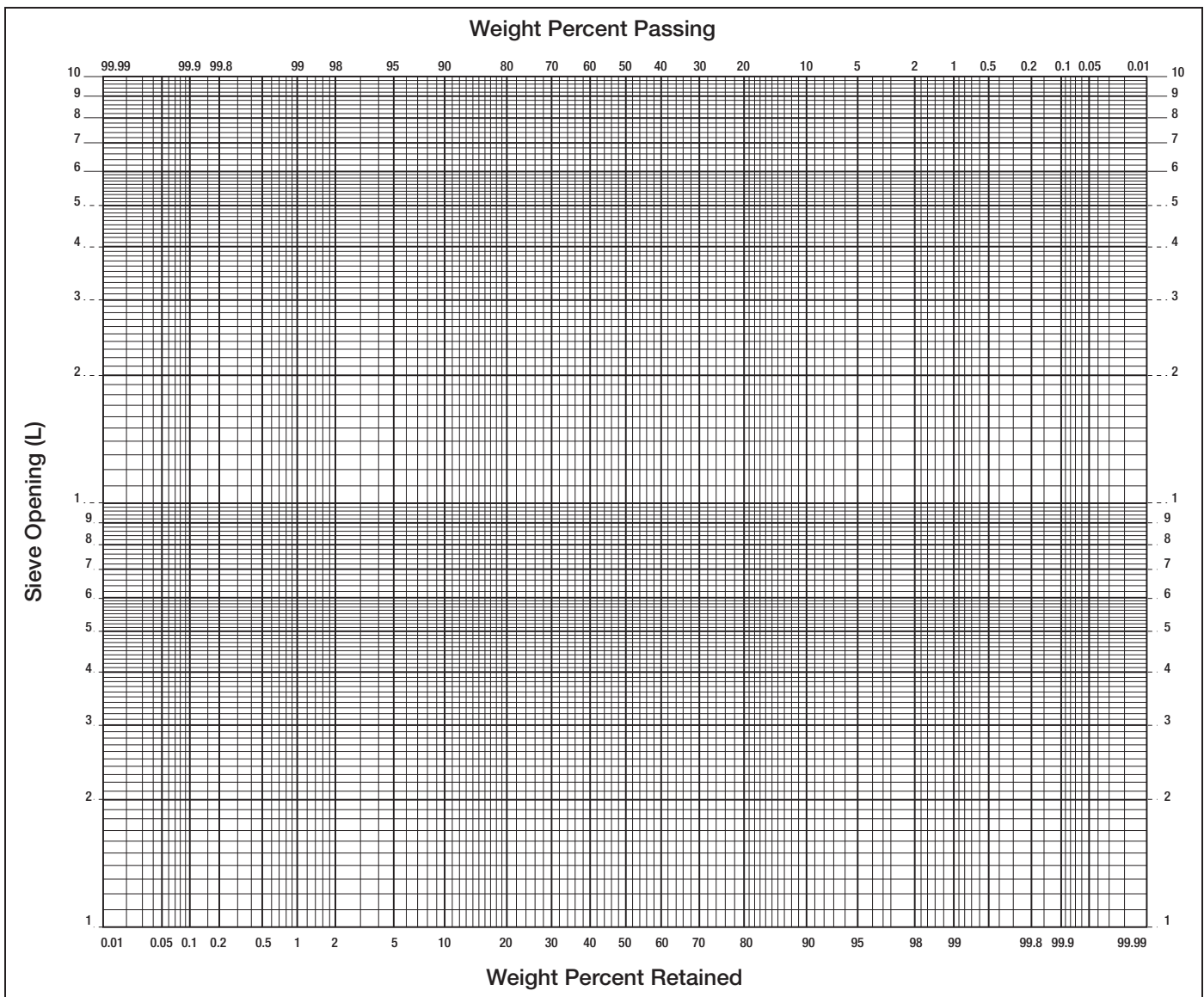

Figure 1: Log Probability Graph Coordinates

for the sieve opening and the probability axis for cumulative weight percent passing or retained on each sieve in the series. A different distribution, for a sample of natural sand from a "frac" sand deposit, is shown in Fig. 3. These two sieve analyses can be used to illustrate the influence on screen performance of differences in particle size distribution.

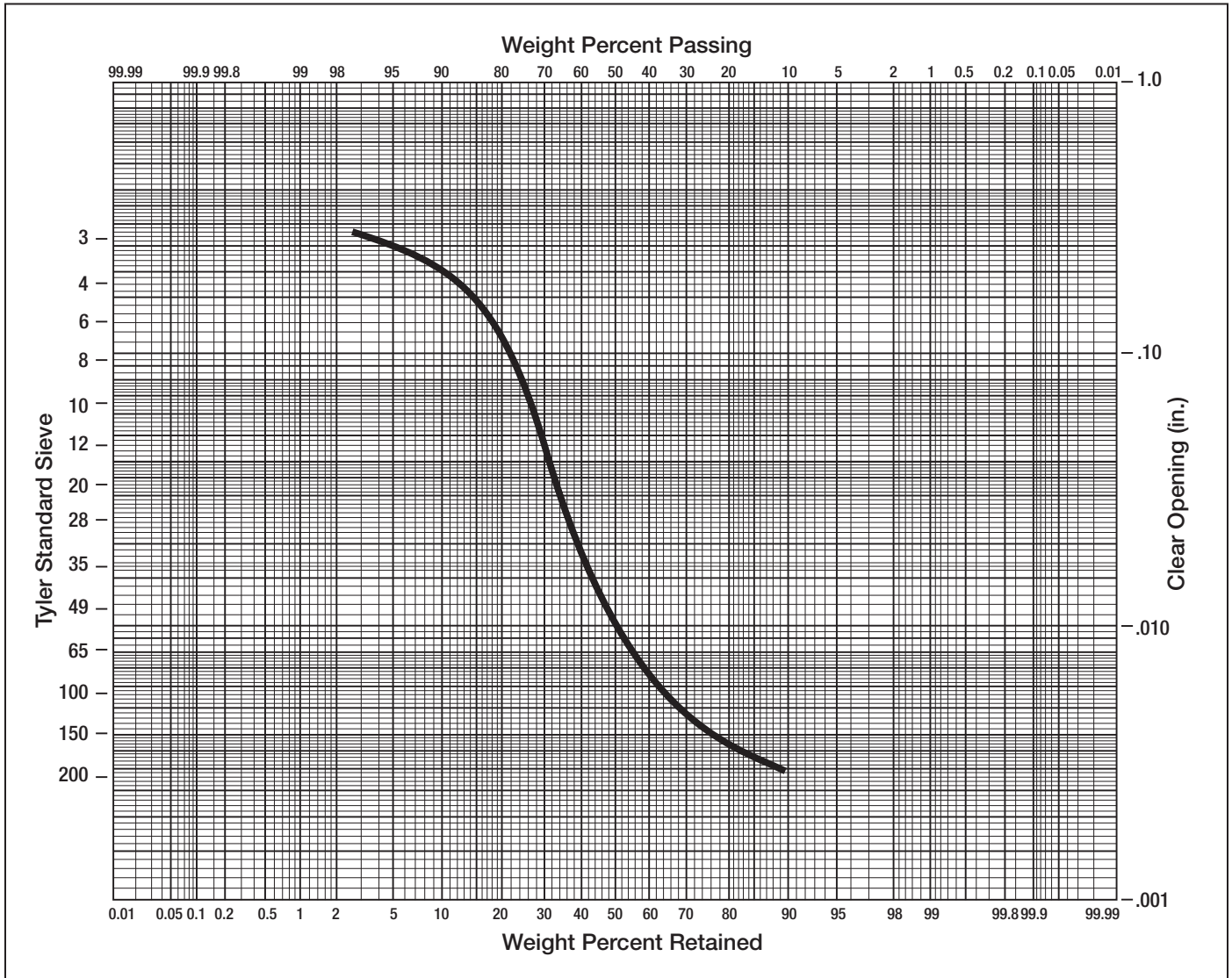

Figure 2: Communitized limestone size distribution

A "cutpoint", at the intersection of a line drawn horizontally from the y-axis, and a vertical line from the x-axis, defines the percent of the feed that passed the selected opening in the test sieve used for the sieve analysis. This is the reference for calculating the efficiency of any other screen having the same opening. The test procedure is designed to allow all the particles that can pass the opening sufficient time to get through, recognizing that, as the effective particle diameter approaches the screen opening dimension, the chances for it to get through the opening diminish as the square of the difference between them. The rate of change of this difference is expressed in the

slope of the distribution curve as it passes through the cutpoint. In practical applications, as the rate increases (slope becomes steeper) the decreasing proportion of particles approaching the opening dimension has two benefits: (1) the cutpoint becomes sharper, with consequent improvement in separation efficiency; and (2) it may allow for an increased opening dimension, improving yield in the fraction under the desired cutpoint, without exceeding specified oversize limits.

As an example, refer to Fig. 2, the sieve analysis of a sample of comminuted limestone.. The curve slopes steeply between about 8 mesh and 48 mesh. If the desired cutpoint is within that range, at 28 mesh, and the screen opening is increased one full interval $\sqrt{2}$ on the Tyler scale, to 20 mesh, the undersize fraction in the feed will increase from 64 to 67%, from the addition of the 3% 20x28 m. fraction.

While the probabilities of passage of all particles 28m and smaller are improved by the larger opening, thus increasing the undersize yield, the probability that a 28m. particle will be found in the undersize has only been increased from zero to 1 chance in 30.

Compare this with the flatter distribution of Fig. 3. If the desired cutpoint is set at 28 mesh, at 84% passing, and the screen opening is enlarged one interval to 20 mesh, the undersize fraction in the feed will increase by 8%, to 92%. The probability for passage of the 28 mesh particle into the undersize remains the same as in the previous example, meaning that the potential for exceeding a specified limit for oversize in the undersize fraction is almost 3 times greater for the flatter distribution.

As a general rule, screen capacity at any given level of efficiency, other things being equal, will be dependent not only on the size of the aperture, but also on the slope of the size distribution curve through the cutpoint. This latter characteristic is taken into account in the test-data-based Fractional Efficiency calculations⁸. The Capacity Estimating Methods⁹, at a baseline efficiency of 85%, include correction factors for variances in slope of a known or assumed size distribution.

Machine Factors

THE SCREENING MEDIA

There are many varieties of screening media. The most common, available in carbon steel, stainless or other metal alloys, is woven wire screen, made with openings that may be either square or rectangular. Others include profile bars, perforated plates, polyurethane and rubber. The importance of making the best selection of media for any screening application cannot be overstated. In any screening machine, the media will affect performance in terms of capacity, efficiency and cost. Manufacturers of screening equipment will offer their recommendations. Much has been written on the subject¹⁰, but often the best results are achieved through trial and error.

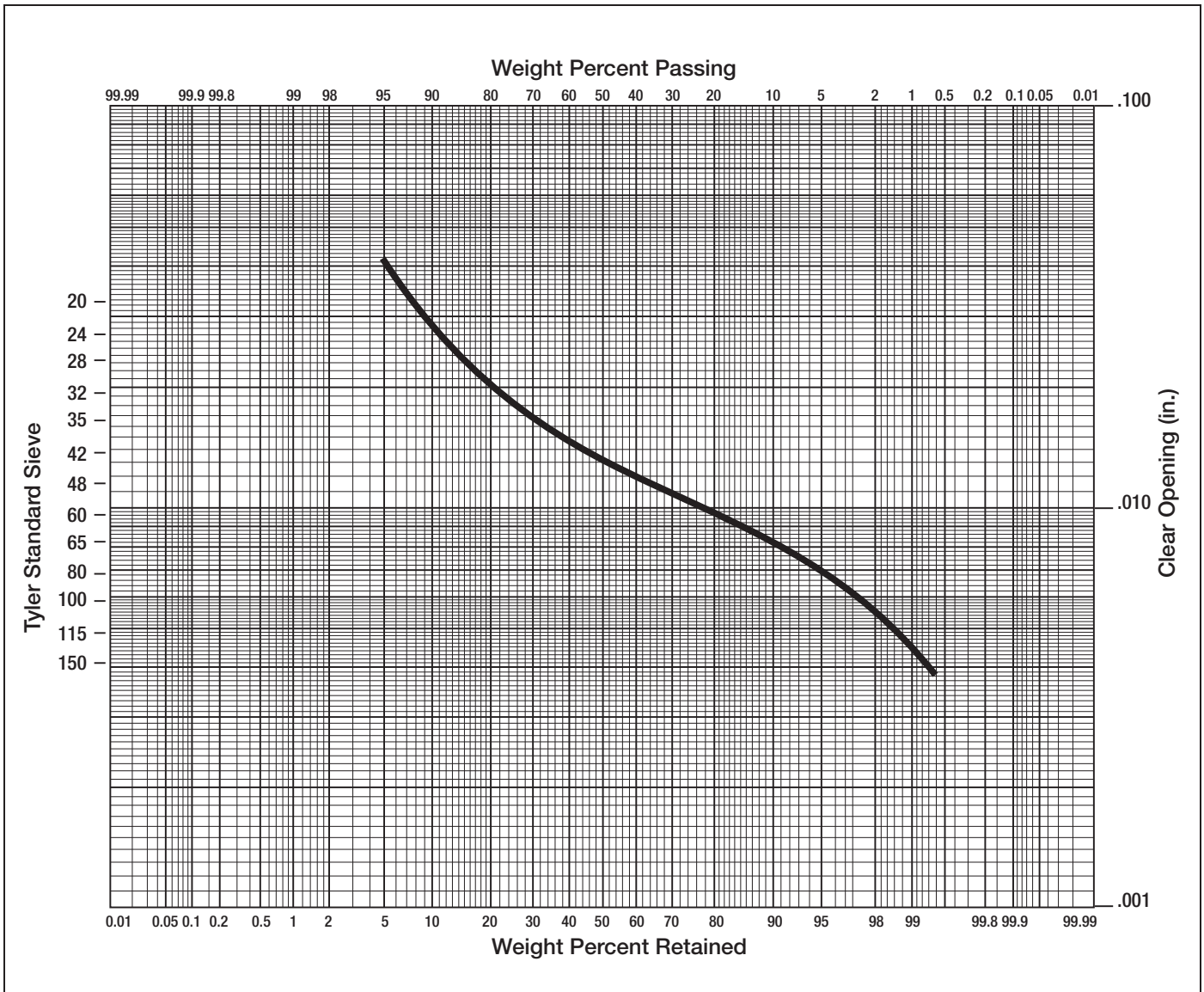

Figure 3: Frac Sand Sample FSI

MOTION

Screening requires relative motion between the sieve and the particle mass. In a few specialized cases the sieve is stationary, but in most commercial screening applications, the particle mass flows over a sieve to which some kind of motion is mechanically applied. Its velocity determines the volumetric flow rate of the particle mass over the sieve, whose motion is intended to enhance both the flow and the passage of undersize through the sieve. This motion takes several different forms, depending on the design of the screening machine. It may be circular in the horizontal plane; gyratory, with a vertical rocking oscillation superimposed on the circular motion; oscillating in a straight-line, simple harmonic motion; vibrating with a circular motion in the vertical plane; vibrating with a linear pitching motion on a horizontal sieve having both vertical and horizontal components; or vibrating only in the vertical direction. In each case, the surface is sloped as required to obtain the desired mass flow, usually at velocities between 40 and 100 fpm.

In most designs the screen media, if woven wire, is stretched taut over a supporting frame and the vibration is applied through the frame. The vibration is forced, usually by rotating unbalanced weight(s) driven by an electric motor. For circular motion in the horizontal plane, the unbalance is rotated on a vertical axis. Circular motion in the vertical plane is generated by unbalances rotating on a horizontal axis. Straight-line motion is generated by one or more of a pair of unbalances contra-rotating on horizontal axes. The unbalances are driven by electric motor(s), usually through V-belt transmissions, or in a few designs directly connected to, or mounted on, the motor shaft.

These forced-vibration systems are self-balancing, in that the forcing mechanism is an integral part of the vibrating frame so that the W_r of the mechanism equals the W_r of the vibrating assembly, which is elastically supported on springs.

The tuned spring-mass, or natural-frequency, vibrating conveyor is sometimes adapted, in balanced or unbalanced versions, to screening applications¹¹

In a few exceptions, the vibration is applied directly to the screen media mounted in a stationary frame. The vibrating force can be generated by rotating unbalances, or by electromagnetic vibrators.

Mechanical details and performance claims for each type are described, more or less accurately, in the manufacturers' literature.

MOTION IN THE HORIZONTAL PLANE (SHAKING SCREENS)

In most of the designs employing motion in the horizontal plane, the amplitude and frequency (rpm) are fixed. Amplitudes range from 1/2" up to 1-1/2" in the oscillating, (straight-line), and up to 3" mean diameter in the circular and elliptical designs. Straight-line oscillating motion is generated by one or more pairs of unbalance weights contra-rotating on a horizontal axis. Circular motions are generated by weights rotating on a vertical axis. This axis may be slightly inclined to produce a gyratory effect. Frequency, or rpm, is selected for peak accelerations of up to 3-1/2 g.¹² The axis of rotation may oscillate slightly to produce a gyratory motion. In all but the gyratory designs, the screen surface is sloped slightly to induce or enhance material flow. At a slope of 5°, the force component normal to the surface is a small fraction, about 1/4 to 1/3, of the weight of the particle mass on the surface.

This is the distinguishing characteristic of all the horizontal motion designs: the particle mass slides smoothly over the screen without bouncing, providing for the stratified undersize particles the best opportunity to find and pass an opening. The advantage is somewhat diminished by the ease with which an on-size particle can get stuck in an opening, resulting in progressive blinding of the screen. For that reason, these machines must all incorporate some means for impacting the screen surface from underneath to dislodge the stuck particles. The most common is the resilient elastomeric (bouncing) ball, supported under the screen by a coarse wire mesh, and contained in groups of three or more within a matrix of confined areas. The random impacts of the balls against the screen prevent the development of progressive blinding. As an additional benefit, the transient local turbulence caused by the impacts improves efficiency by roughing up the smoothly flowing material bed to prevent packing.

MOTION IN THE VERTICAL PLANE (VIBRATING SCREENS)

Vibrating screens are characterized by motion components in the vertical plane ranging from +/- 3.5 to 6 g or more. The lifting and dropping effect expands the material bed; individual particles are bounced along over the screen with reduced opportunity for finding and passing an opening. This is a disadvantage, compared with the smoother horizontal motion designs. But on the plus side, the strong normal force component acts to eject near-size particles stuck in the openings, thus resisting progressive blinding, and the turbulent expansion of the material bed prevents packing. These advantages gain strength with increasing bed depth and particle size.

The two most common types of vibrating screen are the inclined and the horizontal. In the inclined screen, the single unbalance, rotating on a horizontal axis, generates a circular motion in the vertical plane. Since this motion has no positive transport property, the screen surface is sloped at 15-20° to cause the particle mass to travel at velocities of 60 – 100 fpm. The horizontal screen employs a pair of unbalances, rotating in opposite directions on parallel horizontal axes, to generate a straight-line reciprocating motion, inclined to the plane of the screen surface at 40 – 50°. Travel rates on a horizontal surface range between 60 and 80 fpm, and can be increased if necessary by inclining the screen downward at up to about 10°.

The vibrating conveyor is in the same class as the horizontal vibrating screen, but with significant differences that limit its usefulness for screening. Its natural frequency operating system, intended for conveying dry bulk granular materials on a smooth surface, is fixed in a longer stroke, lower frequency regime than the vibrating screen. Peak accelerations are generally below the threshold for blinding prevention. Efficiency, mediocre at best, deteriorates rapidly for separations below about 1/8".

Vibrating screen performance can be optimized for any application by changing amplitude (stroke) and frequency (cpm or rpm). Tests have shown that the screening rate is more responsive to changes in amplitude than in frequency¹³ (Fig. 4), although higher frequencies are helpful in resisting near-size blinding. As a general rule, the amplitude should increase with particle size, or increased bed depth, and frequency adjusted to maintain peak acceleration in the normal range of +/- 4-6 g¹⁴. Amplitude and frequency are related to peak acceleration in simple harmonic motion, or centripetal acceleration in circular motion, in the simplified formula

$$g = 1.42 N^2 \cdot E^{-5} \quad (2)$$

where

g is a multiple of the normal acceleration due to gravity;

N= frequency (rpm or cpm)

S= total stroke (in.)

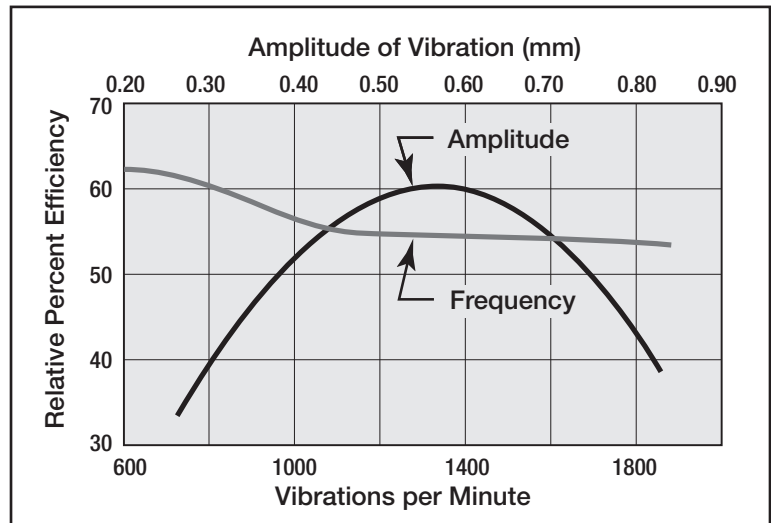

Figure 4: Relative Screening Rate vs. Amplitude and Frequency

The relationship between feed rate (proportional to depth of material bed) and optimum amplitude at constant rpm is illustrated in Fig. 5. Note that in this test peak efficiency was obtained at successively greater amplitudes as feed rate was increased, but the relative efficiency at each successive peak declined, as shown by the optimum amplitude envelope line. This was only one test sequence, on a laboratory-sized inclined circle-throw vibrating screen, but it supports a cautious generalization that there is no one combination of frequency (rpm or cpm) and amplitude that can promise best performance without confirmation by test, in any particular application and feed rate.

In the special case where vibration is applied directly to a woven wire screen cloth, creating a unidirectional vibration normal to the screen surface, the amplitude is limited by the strength of the screen wires, but frequency is variable, up to about 3600 cpm. The limited amplitude is compensated for with a steep inclination of the screen surface, in the range of 35 - 45°. The screening action is created by the vibration of the screen cloth, which slightly stretches the wires and discourages plugging with nearsize particles. Obviously, the applications are limited to fine screening, with wire diameters less than about .025". The width of screen openings has to be increased to correct for the slope, by dividing the desired cutpoint by the cosine of the angle.

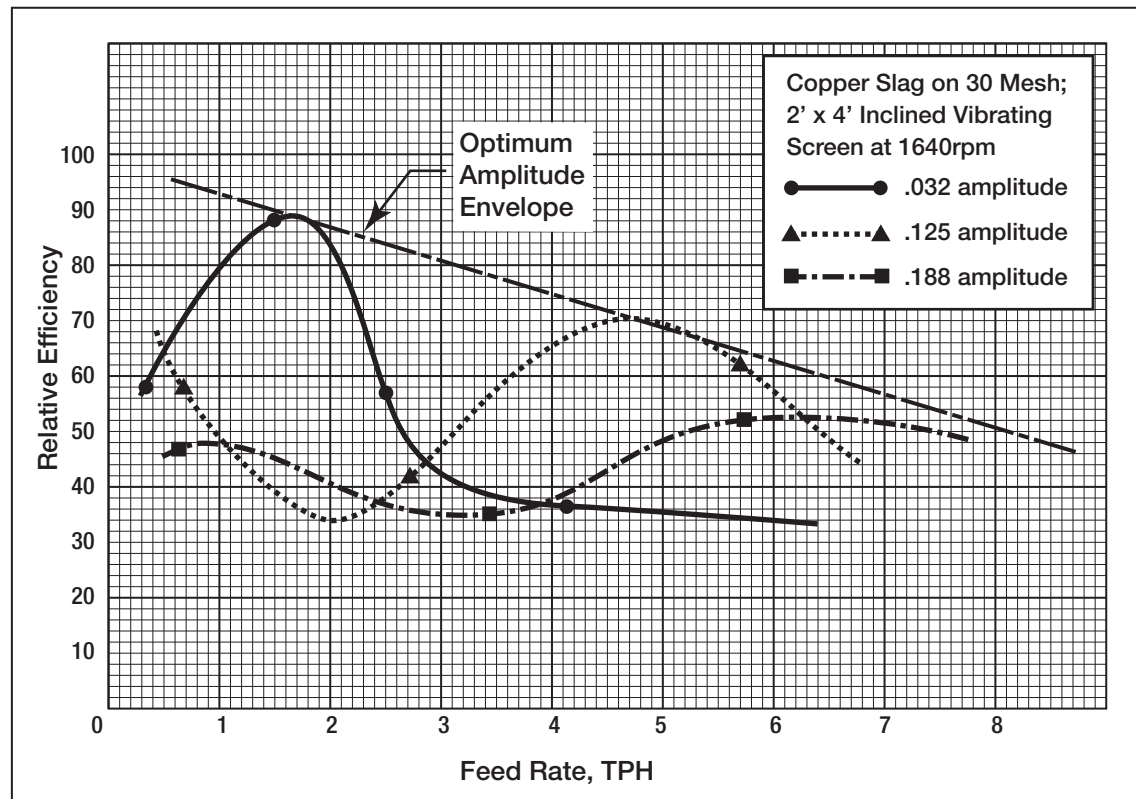

Figure 5: Optimum Amplitude Envelope

PART 3. THE SCREENABILITY CHARACTERISTIC

The performance of any screening machine can be expressed in two variables: capacity, in units of tons or pounds per hour, and efficiency, as defined previously. These are not independent; efficiency will usually, but not always, vary inversely with loading. "Commercially perfect" efficiency is said¹⁵ to be 95%, but this is rarely achieved in actual practice, 85-90% being more realistic when empirical formulas instead of actual test results are used for predicting (guessing at) screen area requirements.

"Screenability" is essentially a measure of the rate of stratification of the specific granular material to be separated. When correctly scaled testing with a representative sample is not feasible, a simple laboratory test using a sieve shaker can supplement empirical capacity calculations for cutpoints below about 8 mesh.

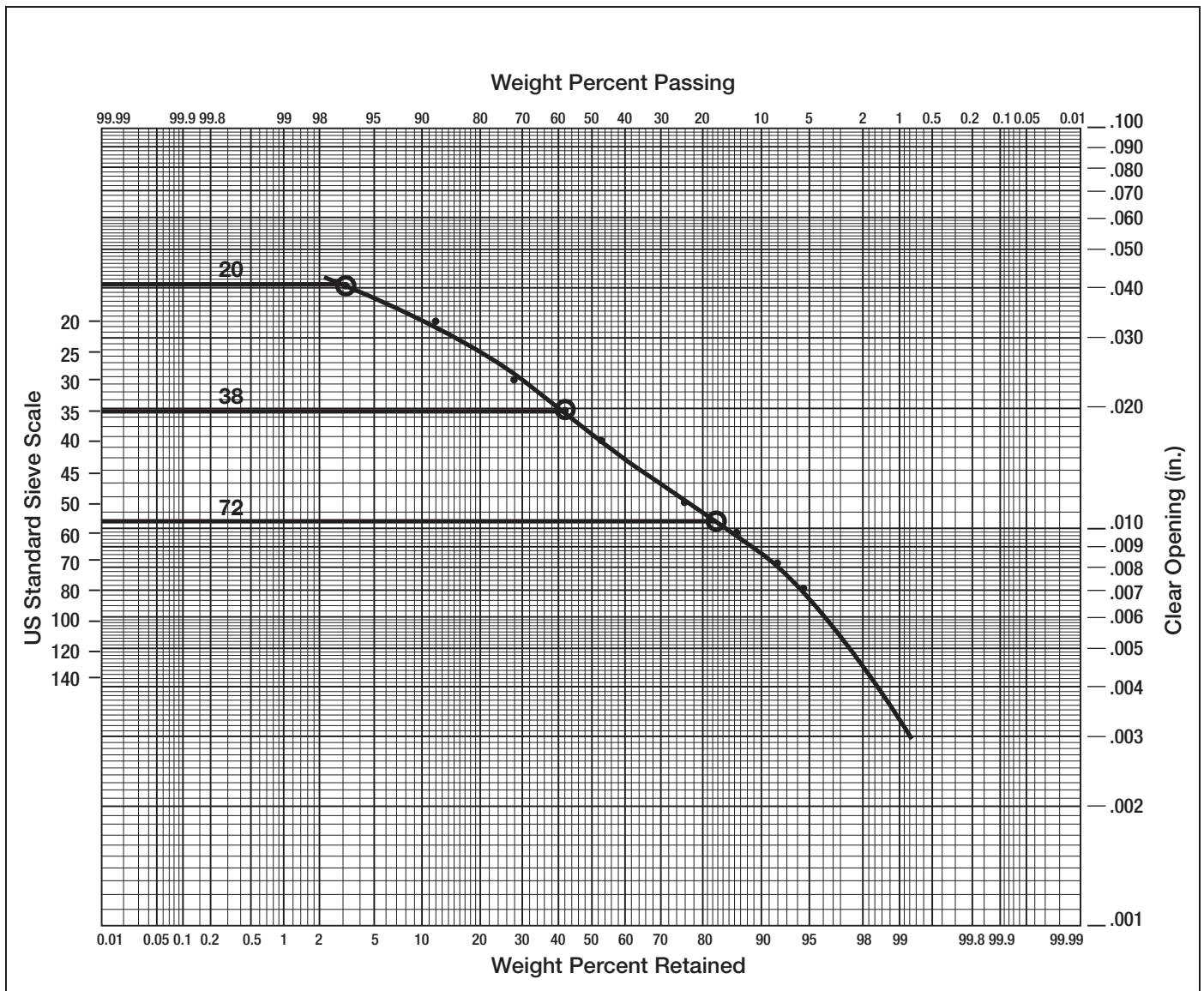

Figure 6: Frac Sand Sample FS-2 Size Distribution

The Screenability Test requires only a laboratory sieve shaker (the W. S. Tyler Ro-Tap is preferred), a test sieve with its wire mesh screen matching, or close to, the cutpoint to be evaluated, a collecting pan under the sieve, and a stopwatch. The purpose of the test is to compare the time rates of recovery of the undersize at different initial bed depths on the sieve. The range of time intervals and depths tested is chosen to bracket the expected depth and retention time in the proposed application. A test that was conducted in the Triple/S Dynamics laboratory can be used as an example. The material was sand from a different frac sand deposit, having the sieve analysis plotted on the log-probability grid in Fig. 6. The bed depths tested, on a 40 mesh test sieve (US std), were 1/4", 1/2", and 3/4". A representative portion of the original sample was loaded to the selected depth on the test sieve, handling it carefully to avoid shaking, and the shaker was operated at successive time intervals, weighing the accumulated contents in the undersize pan after 5, 10, 15, and 60 seconds, and thereafter at 1 min. intervals until there was no further increase in the accumulated undersize. The results for each depth were used to plot the resulting constant-depth curves in Fig. 7, showing percent efficiency vs. time for each depth tested.

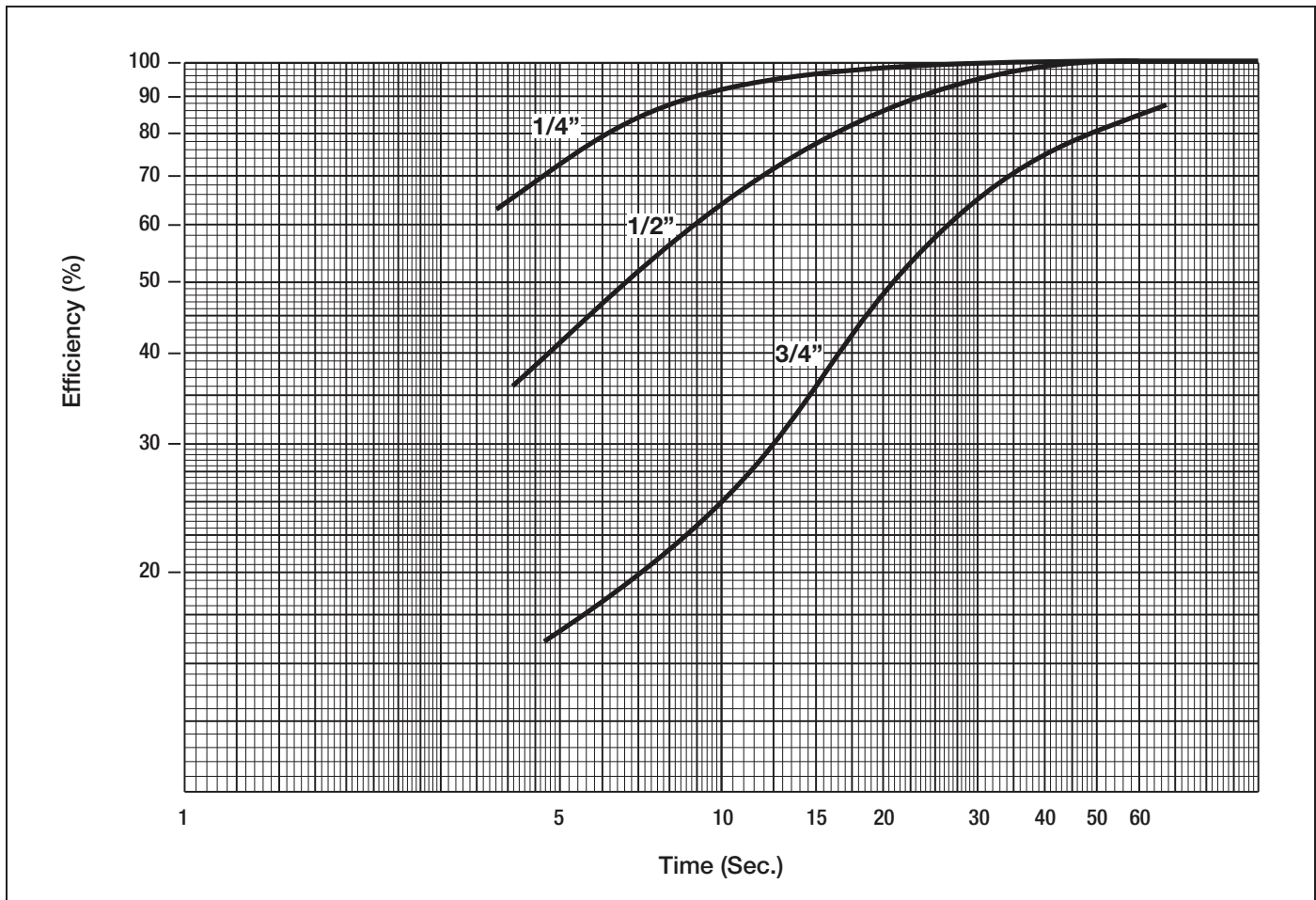

Figure 7: Screenability Characteristic, Frac Sample FS-2

These curves can't be used to predict the performance of any particular screening machine that doesn't exactly match the action of the laboratory sieve shaker, but they do provide a useful insight into the stratification characteristic of the sample being tested. This has a direct bearing on the relation between capacity and efficiency in the proposed application. Retention time, on a screen of a given length, is inversely proportional to the velocity of the particle mass moving across the screen. Bed depth is directly proportional to feed rate and inversely to the velocity, expressed by the formula

$$d = \frac{400F}{\rho VW} \quad (3)$$

Where

d = Bed Depth, in.

F = Feed Rate, stph

r = Bulk Density, lb./ft³

V = Travel Rate, ft./min.

W = Net Width of Screen, ft.

The purpose of the Screenability Test is to evaluate the relationship between retention time and bed depth.

The data plotted in the curves of Fig. 7 are not used in our capacity estimating methods. They can, however, be used to predict the relative effect of a change in feed rate for a rectangular screen of a given length, using the known or assumed travel rate in the equipment selected for the application. For example, retention time on a TEXAS SHAKER® with 10 ft. of screen length and a normal travel rate of 40 fpm will be 15 seconds. From the screenability test, the efficiency at 15 seconds on the 40m. screen with an initial bed depth of 1/4" is 97%. When the depth is increased to 1/2", the efficiency at 15 seconds drops to 78%, a 20% reduction. At 3/4" depth, efficiency is 37%, a 62% reduction.

Retention time in this example is directly proportional to screen length, at the same 40 fpm travel rate. If the length is doubled, to 20 ft., capacity will be unchanged, but the efficiency at 1/2" increased to 95%, a gain of 22%. Alternatively, if the width is doubled to reduce the bed depth to 1/4", capacity will still remain the same, but efficiency goes up to 97%. The screen area is doubled either way, but there is a slight advantage in efficiency from doubling the width while holding the length constant.

Screenability efficiencies are unique to the laboratory sieve shaker employed in the test procedure. A calibration factor is needed to predict efficiencies of a production machine from the Screenability Characteristic curves of efficiency vs. bed depth and retention time. This can be derived in the following way. For this example, the production machine to be calibrated was the Triple/S Dynamics TEXAS SHAKER®, simulated with a full-size narrow width single deck laboratory version which duplicated the rpm, amplitude, slope, pitch and length of the commercial design. The 10 ft. length of the active screen surface was

divided into five two-ft. increments, and the undersize at each increment was collected and weighed separately. At the 40 fpm travel rate over the screen, each increment represented a time interval of 3 sec. Three test runs were made, with the same frac sand sample used for the Screenability test (Fig. 6). Screens were stainless steel bolting cloth. The 72 mesh cloth was backed up with a 10m., .020" dia. wire screen.

Run 1. 20 m. .041" c.o. Bed depth 0.3 "

Run 2. 38 m. .0198" c.o. Bed depth 0.25"

Run 3. 72 m. .0102" co. Bed depth 0.15"

Screen efficiency, related to the size distribution in Fig. 6, was calculated for each successive 3 sec. interval for each of the three runs, and plotted on rectangular coordinates in Fig. 8. This was 94% for Run 2, (15 sec. at 1/4") at 1/4" depth on the 38m. screen. From the 1/4" curve in Fig. 7, the efficiency at 15 sec. was 97%. Neglecting the slight difference in efficiency that would probably favor the 20% larger opening of the 38 m. TEXAS SHAKER® test screen compared with the 40m. Screenability test sieve, the calibration factor is $\text{TEXAS SHAKER}/\text{Screenability} = 97/94 = 1.03$.

The curves of Figs. 7 and 8 are useful in showing qualitatively how screening efficiency is affected by changes in initial bed depth and retention time. In most commercial screening machines, retention time is more or less fixed in the design. The initial bed depth per unit of width, directly proportional to feed rate, is thus the primary control on efficiency. The Screenability curves of Fig. 7 can be used to evaluate the effect of changes in feed rate, using as an example the TEXAS SHAKER® laboratory test results.

At the feed rate corresponding to the 1/4" initial bed depth, (Figure 8) screening efficiency was 94%. To find the expected efficiency from doubling the feed rate, to a depth of 1/2", at the 15 sec. retention in the TEXAS SHAKER®, find the efficiency at 15 sec. on the 1/2" curve (Figure 7). This is 78%. Multiply this by the calibration factor 1.03 determined previously, to obtain the corrected efficiency of 80%.

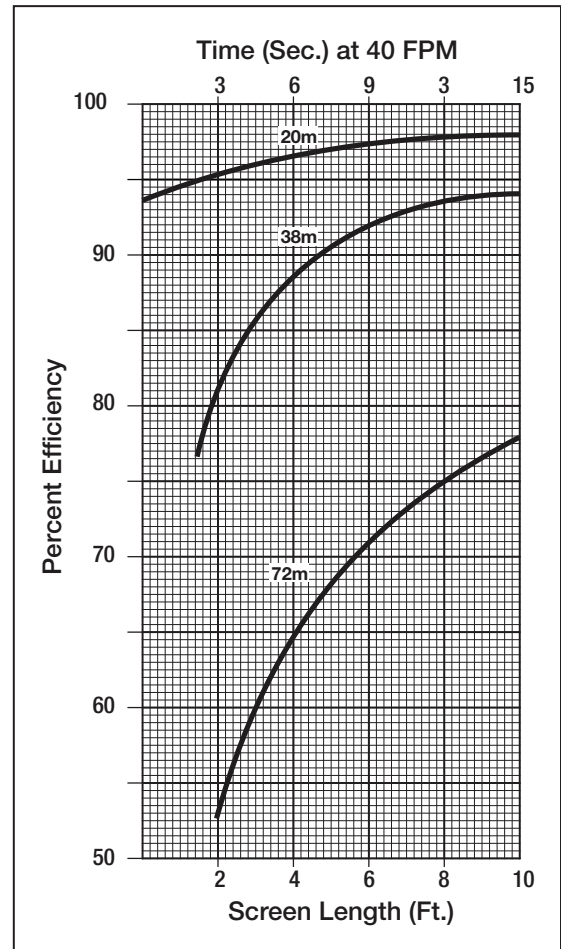

Figure 8: Calibration Curves, TEXAS SHAKER® Scale Test, Frac Sample FS-2

If the calibration factor had been a more significant 0.8, the corrected efficiency would have been 62%; if the factor had been 1.25, the predicted efficiency would have been 98%.

If empirical calculations, instead of scaled laboratory tests, had been used to estimate capacity for a given separation, the usual base efficiency of around 85% would make the calibration factor .90, and the corrected efficiency for the 1/2" depth 70%. The curves of Fig. 7 show that the loss in efficiency resulting from an increase in bed depth from 1/4" to 1/2" can be fully recovered by increasing the retention time from 15 to 40 seconds. This means a proportional increase in length, and a 166% increase in screen area. Doubling the width, which would increase the area by 100%, obviously would achieve the same result.

Position	Time (Sec.)	Percent of Total Removed		
		20m. Screen	38 m. Screen	72 m. Screen
2 ft.	3	97.4	86.3	68.7
4 ft.	6	1.2	8.9	13.8
6 ft.	9	0.86	2.9	8.6
8 ft.	12	0.29	1.1	5.1
10 ft.	15	0.25	0.8	3.8
Total Removed		100.0	100.0	100.0
Feed Rate stph		3.0	2.5	1.5
% Unders in Feed		97	60	18
Percent Eff.		98	96	78

Table 1: TEXAS SHAKER® Calibration Test Throughput vs. Time

Data from these tests can be used to show the rate of passage of undersize through the screen. In Table I, the percentage of total undersize collected from each section is tabulated against the 2 ft. length increments for each of the three screens. In the last interval, between 8 ft. and 10 ft., the amount collected as a percent of the total undersize was .25%, .8%, and 3.8% for the 20, 38 and 72 m. screens, respectively. The percent undersize in the feed was 97, 60 and 18. The related screening efficiencies were 98, 94 and 78%. It can be seen that more than half of the total in all three cases is recovered in the first 2 ft. The rates of change with length (proportional to time) diminish so rapidly in all three cases that overall efficiency, even with the 72 m. screen, would not be significantly improved by further extensions of length. The differences between the three rates of throughput, from highest on 20m. to lowest on 72m., reflect not only the diminishing capacity of smaller screen openings, but also the effects of the size distributions of the undersize fractions. A sieve analysis of the undersize in each length increment would show that the median size of the distributions in all three tests shifts from smaller in the first section to coarser in the last section. Fines go first, governed by the probability function, which also explains the different rates of change of efficiency with length (or time) in the three curves of Fig. 8.

The value of the Screenability Test procedures and the conclusions that can be drawn from them is to direct attention to the primacy in screening performance of size distribution (easily measured by sieve analysis), and the probability factor (which can only be crudely approximated by empirical calculations). Only scaled testing with actual material samples, as described above, can accurately predict performance at cutpoints below about 8 mesh.

Some observations can be drawn from a study of the graphs in Figs. 7 and 8, and Table I:

1. Universal “rules of thumb” for optimum depth of bed as a multiple of aperture size are meaningless.
2. Retention time for peak efficiency increases exponentially with bed depth.
3. The rate of change in undersize removal vs. screen length (retention time), which depends on cutpoint, size distribution and bed depth, diminishes rapidly toward zero as length increases. But capacity is always directly proportional to width of a rectangular screen at a given bed depth. This means that in any application with any rectangular screening machine, there will be an optimum retention time beyond which capacity at constant efficiency will be governed only by bed depth.
4. The graphs help to explain why estimates of screen area requirements for cutpoints below 8 mesh, based only on empirical formulas, are not a reliable substitute for actual scaled testing. Nuances in material characteristics, and machine differences, both of which significantly affect performance, are unavoidably neglected in the derivation of the formulas.

Part 4. Estimating Screen Capacity

Actual scaled testing is the best way to predict screen sizing and performance for a new application. When this isn't feasible, or even possible, empirical calculations can provide approximations that are usually better than guesswork. Formulas offered by manufacturers and trade associations are not all the same, and can lead to quite different conclusions from the same input data. Accuracy, in terms of actual vs. predicted performance, is never guaranteed.

The methods presented in this section are subject to the same limitations, but their accuracy is enhanced by their separation into two categories, Coarse and Fine. The dividing point is set at 0.1" clear opening.

I. Coarse Screening Method

This method for estimating screen area requirement for coarse screening applications requires the following information:

- Feed rate to the screen surface, stph (F)
- Percent undersize (U)
- Screen aperture, in. (L)
- Percent half-size in the feed (L/2)
- Bulk Density, lb./cu. ft. (p)
- Particle Shape (natural sand & gravel or crushed stone or mineral ore).
- Percent open area of screening medium selected

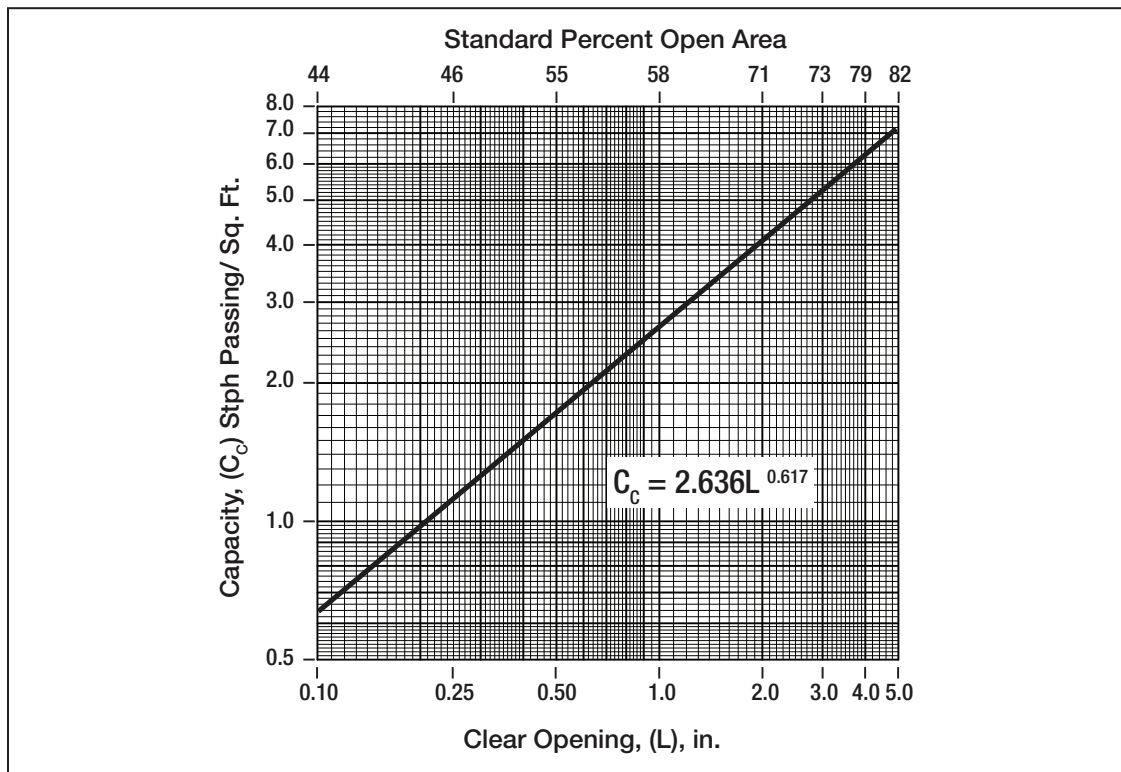

Figure 9: Coarse Screen Capacity

The unit capacity C , in stph/sq. ft., found from the graph in Fig. 9¹⁶, is based on a loose, struck bulk density of 100 pcf, and an assumed screen media percent open area. This targets a screening efficiency of 85 - 90% for applications in the coarse screening regime, assuming dry, free-flowing material characteristics. Moisture limit for dry screening scales upward from 1% at 1/8" to 6% at 1", unlimited above.

Sedimentary minerals such as clays and shales, can be an exception. Granules in bulk may appear to be dry and free-flowing, but as they flow across the screen they may deposit micron-sized particles attached to the screen wires, building up to restrict or block openings up to about 3/8".

In such cases, the unit capacities from Fig. 9 can be used at 3/8" and below if the screen surface is heated to break the adhesive bond holding the agglomerated fines to the wires (see "ELECTRIC HEAT" below).

The screen area, in square feet, is found by dividing the weight of material, in stph, passing the specified opening by the unit capacity from Fig. 9, and adjusting for the factors K_1 K_7 , defined in Formula 4:

$$A = F \times U \div [100C_c \cdot K_1 \cdot K_2 \cdot K_3 \cdot K_4 \cdot K_5 \cdot K_6 \cdot K_7] \quad (4)$$

Where

K_1 = Percent half-size to the screen opening (Fig. 10)¹⁷

K_2 = Bulk density/100

K_3 = Particle shape factor, Table II

K_4 = Deck location factor (top, middle, bottom), Table III

K_5 = Aperture shape factor, Table IV

K_6 = Open Area Factor (Divide the standard % open area from Fig. 9 by the actual for the screen or perforated plate selected).

K_7 = Bed Depth Correction Factor (Fig. 11, K_7 vs. D/L).¹⁸

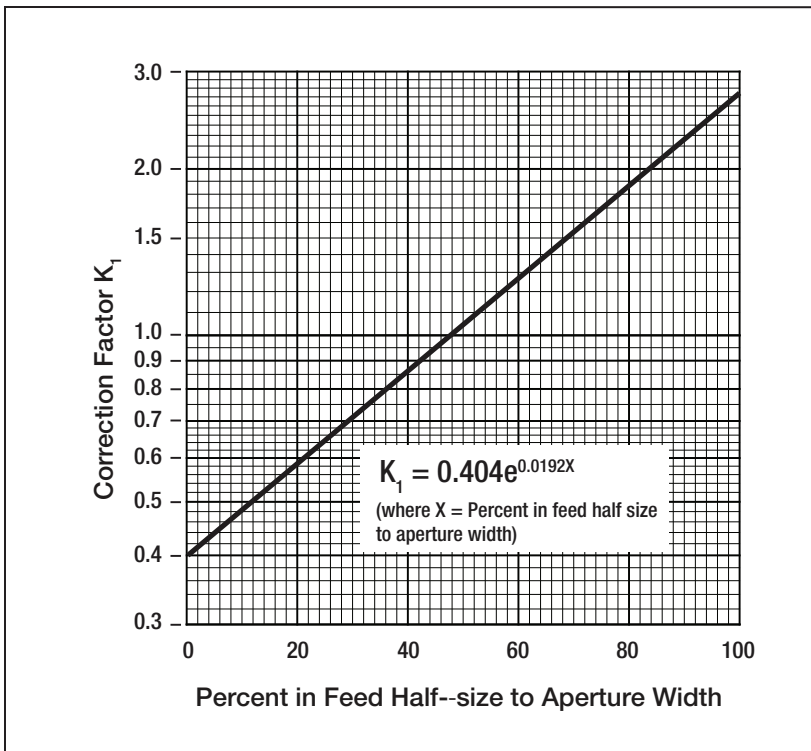

Figure 10: Half-Size Correction K_1

The half-size correction factor K1 and bed depth correction factor K7 together attempt to adjust for the impedance of the average oversize depth on the screen surface by taking into account the depth of the material bed retained on the screen at the discharge end, and the slope of the feed material size distribution through the cutpoint. Obviously, these empirically derived factors can be a major cause for differences between predicted and actual performance.

The bed depth is a function of percent oversize, travel rate on the screen, bulk density, and width of screen surface at the discharge, expressed as

$$D = 400[F \times (1-U/100)] \div \rho VW \tag{5}$$

Where

D = depth of material bed at the discharge.

F = Feed rate, stph

U = Percent undersize in feed

V = Travel rate on screen, fpm (typically 60-100 on inclined vibrating screen, 40-60 on horizontal or shaking screens)

ρ = Bulk density, lb./cu.ft.

W = Width of screen at discharge, ft.

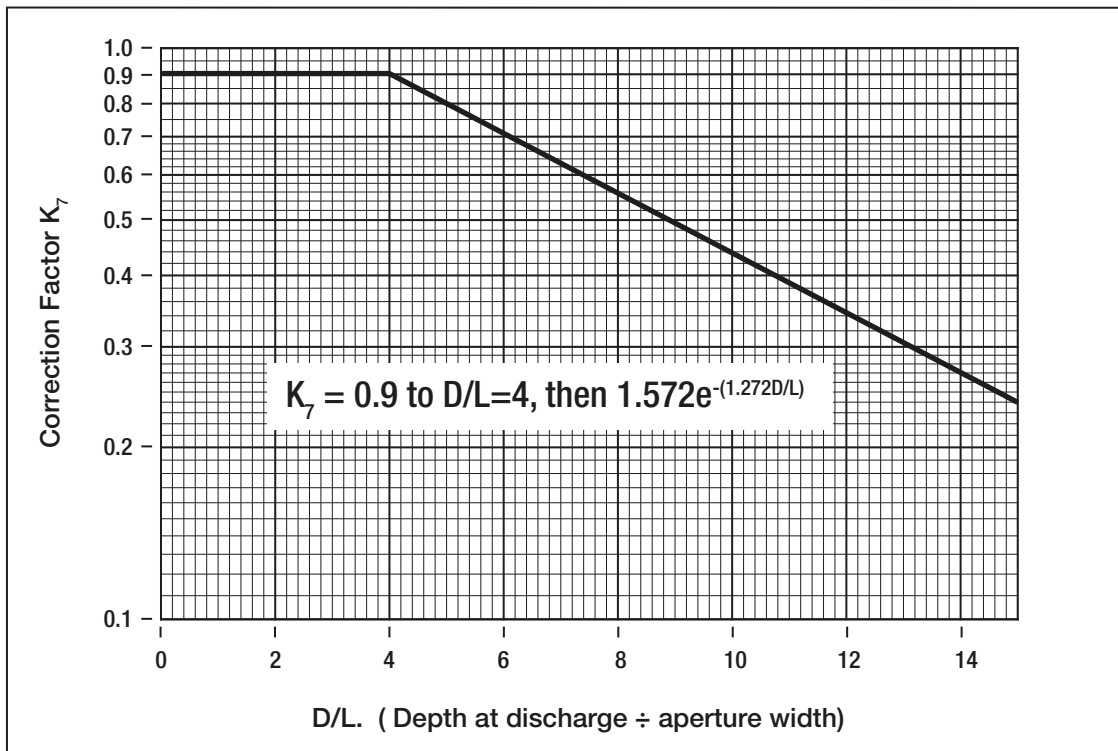

Figure 11: Bed Depth Correction Factor K_7

Note that the bed depth factor K_7 (Fig. 11) is a constant 0.9 at D/L ratios up to 4.0.

Factors K3, K4 and K5 are taken from Tables II, III, and IV, below.

Particle Shape Factor K3		
	Smooth and rounded (natural beach sands and gravel)	1.2
	Rough and angular (crushed rock, rough natural gravel)	1.0

TABLE II.

Deck Location Factor K4		
	Top deck	1.0
	Second deck	0.9
	Third deck	0.8
Note: Stacking more than three decks in a single unit series separation is not usually practical, due to loss of usable area.		

TABLE III.

Aperture Shape Factor K5		
	Square	1.0
	Round ¹⁹	0.83
Rectangular slot ²⁰		
	Length/width ratio $2 < l/w < 4$	1.1
	Length/width $4 < l/w < 25$	1.2

TABLE IV.

ELECTRIC HEAT

The basic capacity formula (1) can be used for screening ground clays and shales at 3/8" and below if the screen surface is heated to break the adhesive bond holding the agglomerated fines to the wires. The common method is electric screen heating, which can be applied to wire screens weighing up to 1.5 lb./sq. ft. A secondary low voltage, high amperage current from a line transformer flows across two electrically isolated screen surfaces connected in series, through bus bars that also serve as the screen tensioning rails. Typical electrical load is about 1-1.5 KVA/ sq. ft. of screen area.

WET SCREENING

Wet screening is mandatory when moisture exceeds the limits stated above. Water volume should be 5 or 6 gpm/stph, increasing to 8 gpm if the material includes more than 1% attached clay. About 20% of this volume should be added in the feed box, and the balance applied through spray bars spaced at intervals along the length of the screen, with the last bar positioned within 3-4 ft. of the discharge. Spray deflectors over drilled holes in the bars spread the water uniformly across the width of the screen, in a thin curtain angled slightly toward the feed end. When sufficient water is correctly applied, the calculated area can be increased with the water factor K8 from Table IV, in the denominator of the formula.

Water Factor K8 ²¹		
	Screen Opening (c.o.)	
	-20 m	1.3
	+20m-10m	3.0
	+ 10m -4m	3.5
	+ 4m - 3m	3.0
	+3m -3/8"	2.5
	+ 3/8" - 1/2"	1.8
	+ 1/2" - 3/4"	1.4
	+3/4" -1"	1.2
	+ 1"	1.0

TABLE V.

II. Fine Screening Method

Empirical formulas for estimating screen capacities in sizes below 0.1" are increasingly unreliable with diminishing particle size. A computer could be programmed to account for the many variables that affect the probability of passage of undersize particles in a given feed size distribution, but it would be a daunting task, and likely could never match the results from a scaled test.

The formulas presented here are approximations derived from a combination of test data, field experience, plain guesswork, and an assumption that the variables are logarithmic functions. Because of the probabilistic nature of the screening process, empirical formulas are no substitute for experience, or scaled test work.

The basic capacity formula resembles the Coarse Screening formula, but with some differences in the modifying factors. The solution for screen area required for a given application requires the following information:

- Feed rate to the screen surface, lb./hr. (F);
- Percent half-size
- Screen aperture, in. (L);
- Wire dia. or bridge width, (t);
- Percent undersize (U);
- Aperture shape;
- Bulk density, lb./cu. ft. (p);
- Particle Shape;
- Moisture (wt. %)

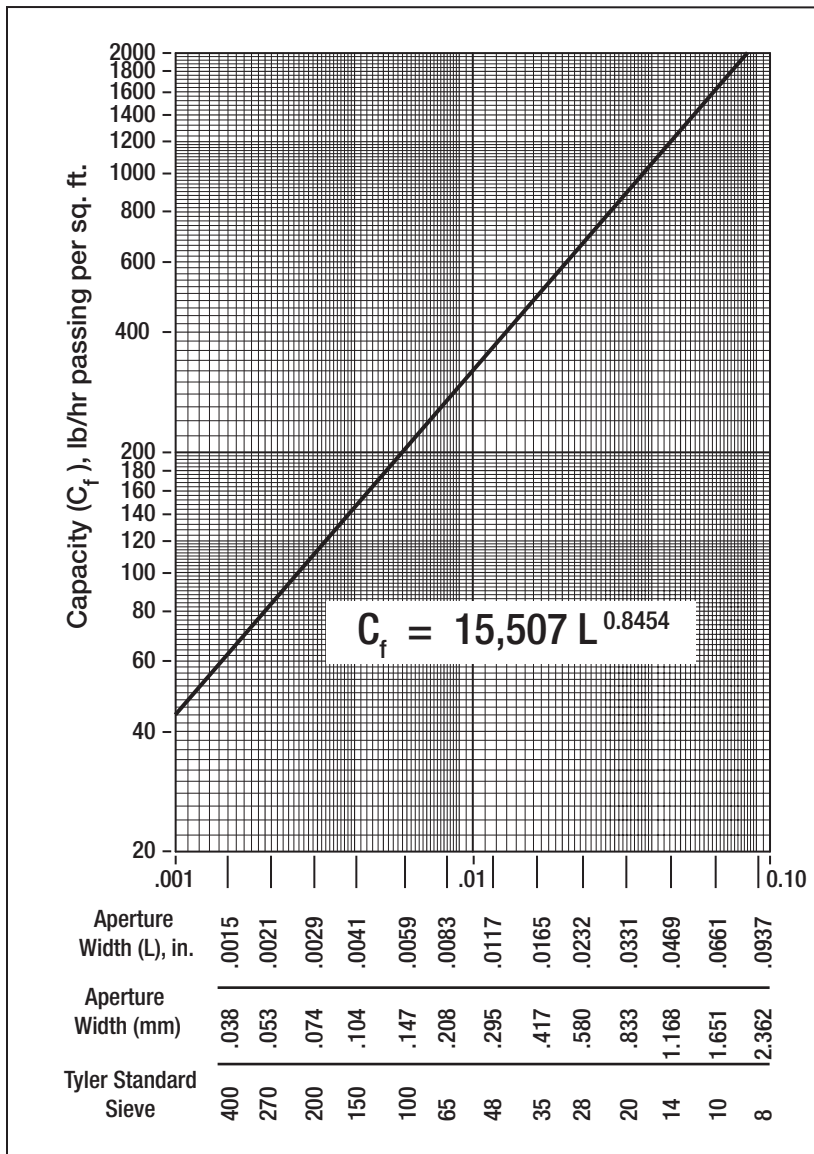

The Unit Capacity C_f , in lb./hr. passing per sq. ft. vs. screen aperture, found from the graph in Fig. 12²², is based on a loose, struck bulk density of 100 pcf, and moisture limited to 1% from 1/8" to 20m, and 0% below 20m.

The estimated screen area, in square feet, is found by dividing the weight of material, in lb./hr., passing the specified aperture, by the unit capacity from Fig. 12, and adjusting for the factors listed below. The targeted screening efficiency is 85%, within a probability range of 68% (one std. deviation). An additional allowance must be made if the feed material contains more than about 5% of extreme fines (<100m) in a continuous distribution. The finer particles may be attracted to coarser particles, forming low-permeability mats that cause progressive blinding of the screen area. Different materials will behave differently, according to their chemical, physical and electrical properties. The resulting uncertainty is expressed in the factor K_x , a "wild card" whose value is left to the judgment and experience of the estimator. There is an additional exception for rescreening and discontinuous size distributions, described above under Coarse Screening Method .

Figure 12: Fine Screen Capacity C_f)

Subject to these exceptions, the estimating formula is

$$A = F \times U \div [100C_f \cdot A \cdot B \cdot C \cdot D \cdot E \cdot F \cdot G \cdot X] \quad (6)$$

Where:

- A= Half-Size Factor, Fig. 13²³;
- B= Bulk Density/100;
- C= Particle Shape Factor, Table I;
- D= Deck Location Factor (top, middle, bottom), Table II;
- E= Aperture Shape Factor, Table III;
- F= Open Area Factor , Fig. 14²⁴;
- G= Slope Factor, Fig. 15²⁵, percent between aperture (L) and half-size (K1);
- X= "Wild Card Factor", allowance for excess fines (may range from 1.0 to 0.50).

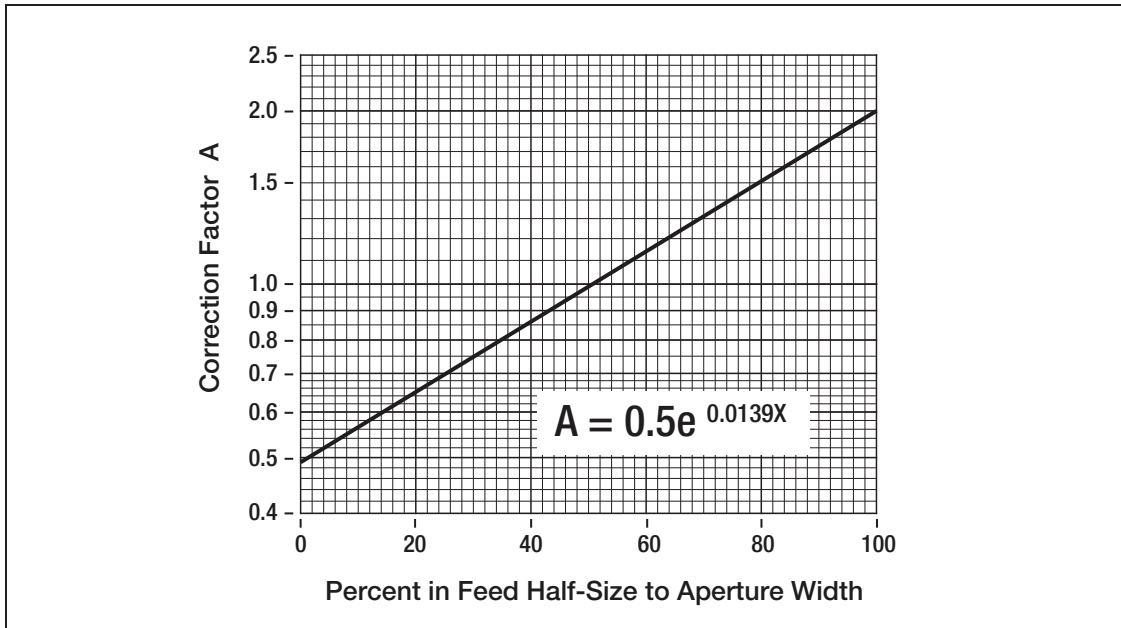

Figure 13: Half-Size Correction A (Fine Screen Method)

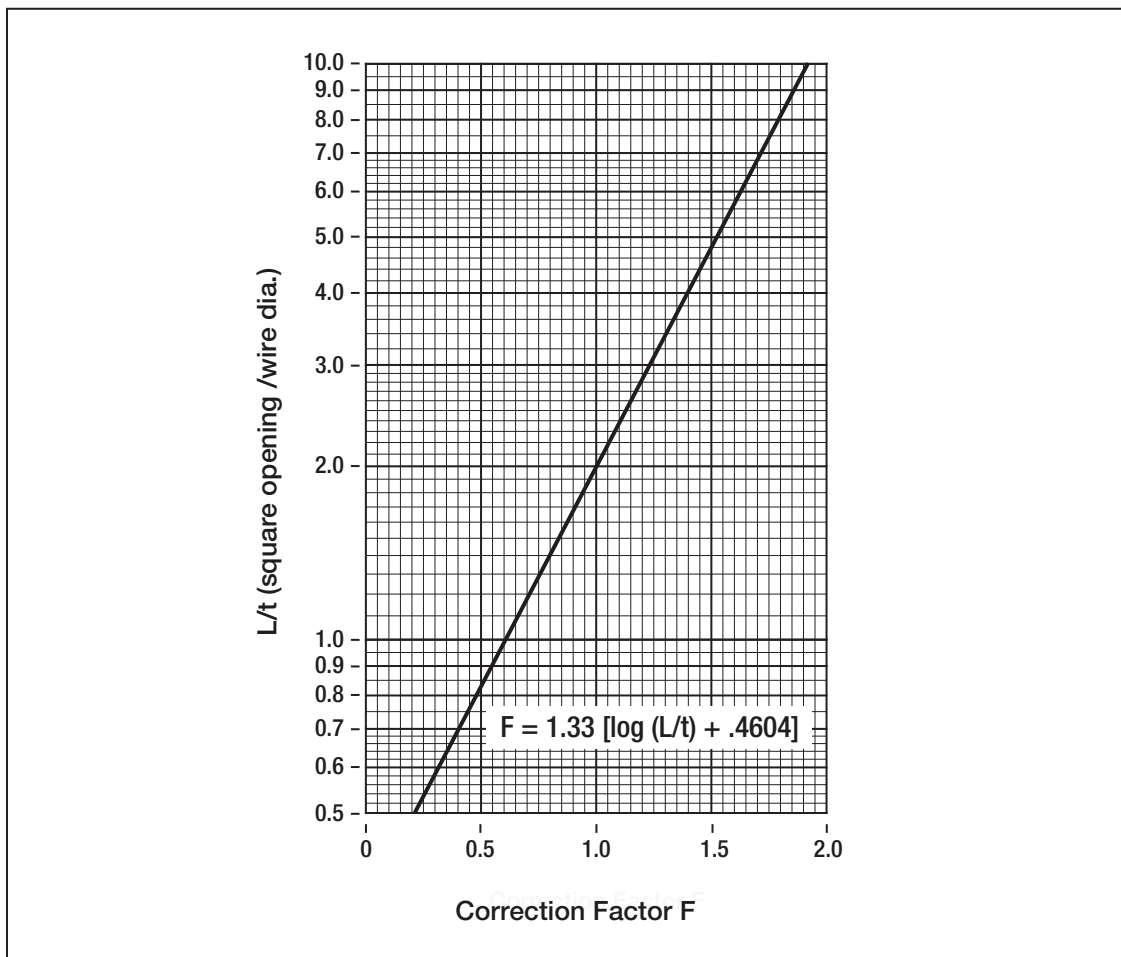

Figure 14: Open Area Factor (fine screen method)

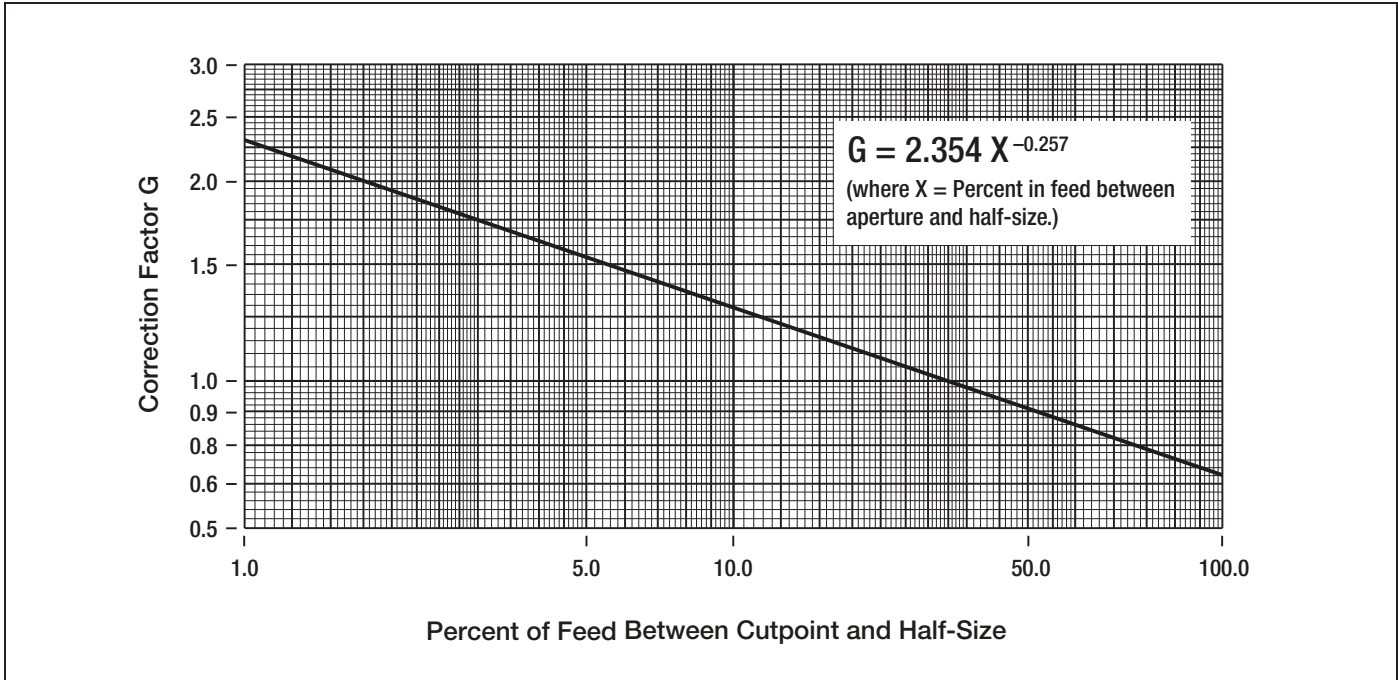

Figure 15: Slope Factor G

ELECTRIC HEAT

Electric screen heating, as described above under Coarse Screening Method, may be needed to prevent screen blinding by adhesion and “plastering” with sedimentary fines even at moisture levels below 1%.

WET SCREENING

The capacity correction factor K8 in Table IV for the water factor can be applied for screening slurries in the fine mesh range, subject to same conditions as in the Coarse Screening Method.

III. Rescreening And Discontinuous Size Distributions

When a previously screened material is screened again over the same openings to recover more of the retained undersize, it is called “rescreening”. The Basic Capacity Formula is unusable, for two reasons: the undersize retained from the first screening is always near-size to the aperture, and the oversize bed impedes stratification. If the screen area is the same as before, efficiency isn’t likely to be better than 40 or 50%, and won’t be much improved by adding more area.

The same limitations apply to any screening application calling for the removal of less than 10% of undersize to the screen opening. If the size distribution is continuous, as in the example of Fig. 2, formulas (4) and (6) will be reasonably accurate within an efficiency range of 60 to 80%, at D/L ratios up to 4, but beyond that limit it should be verified by scaled testing.

A particle size distribution can be characterized as “discontinuous” when 90% or more of the total weight comprises particles within a size range of about 1.5 diameters. This distribution is common to commercial grain cleaning separations, in which grades are differentiated by an allowable percent foreign material (among other criteria), and “foreign material” is defined by the weight percent passing a specified screen opening. For example, the USDA specification for #1 grade soybeans allows 1% of fine material passing a 1/8” round hole, equivalent to a .105” square opening. The chart in Fig. 16 , for Sample A, shows that approximately 2% is less than 0.105”, so that only 1% has to be removed to make #1 grade. This result can be achieved at an efficiency of $1 \div 2 = 50\%$.

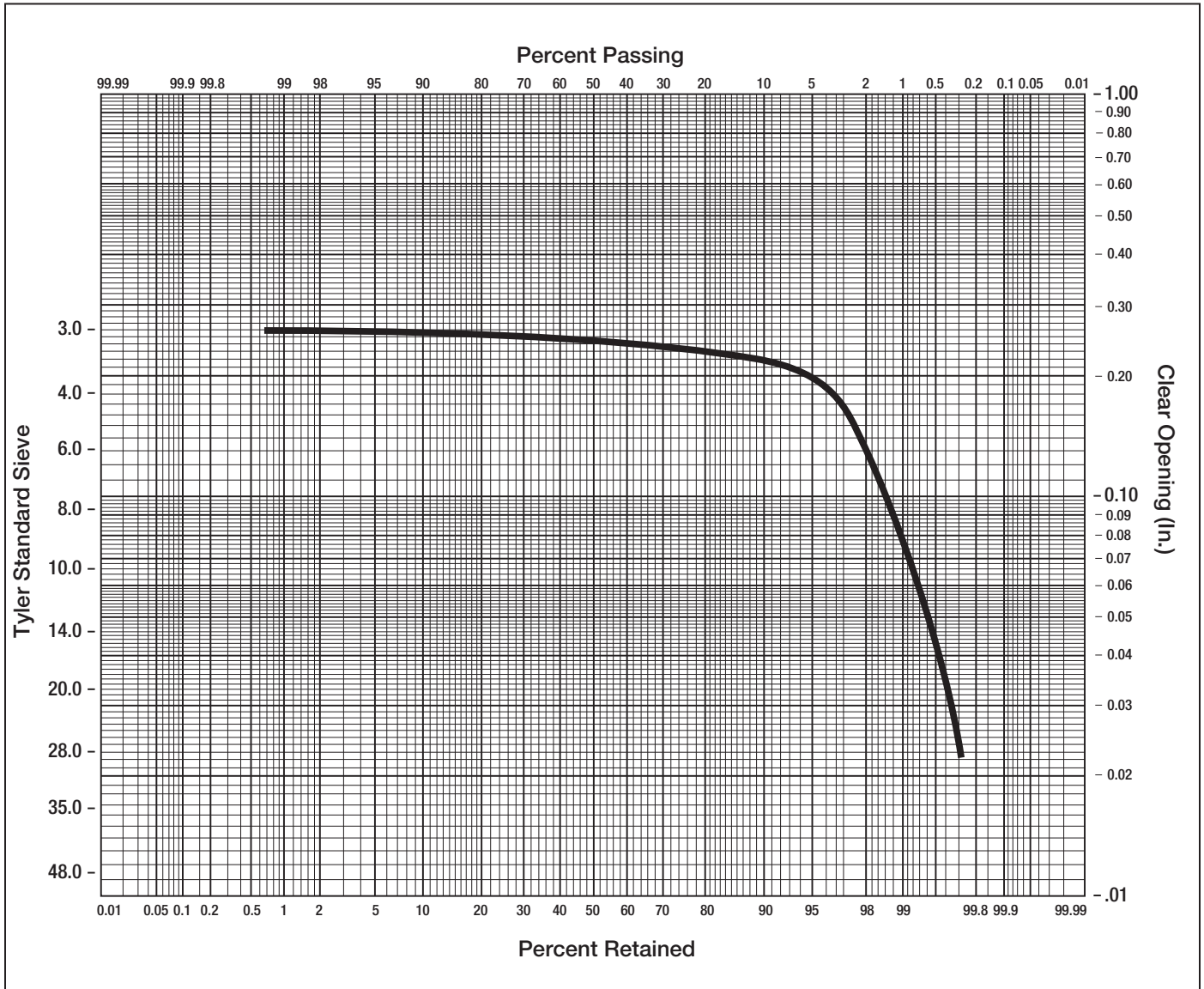

Figure 16: Soybean Sample A

Continuing the soybean example, full-scale testing was performed in the laboratory on samples from two different sources, represented by Samples A and B. Preliminary sieve analyses reported 2.14% minus .131" for both Samples A and B, Figs. 16 and 17. D/L ratios were the same, at about 15. Both were screened at the same commercial production rate, 350 bu/hr/ft. width, on the same 6 mesh wire screen with .131" clear opening. Separation efficiency for the 6m. undersize was found at 49% for Sample B, and 79% for Sample A. The difference can be accounted for by comparing the size distributions of the minus 6 m. fraction in each sample.

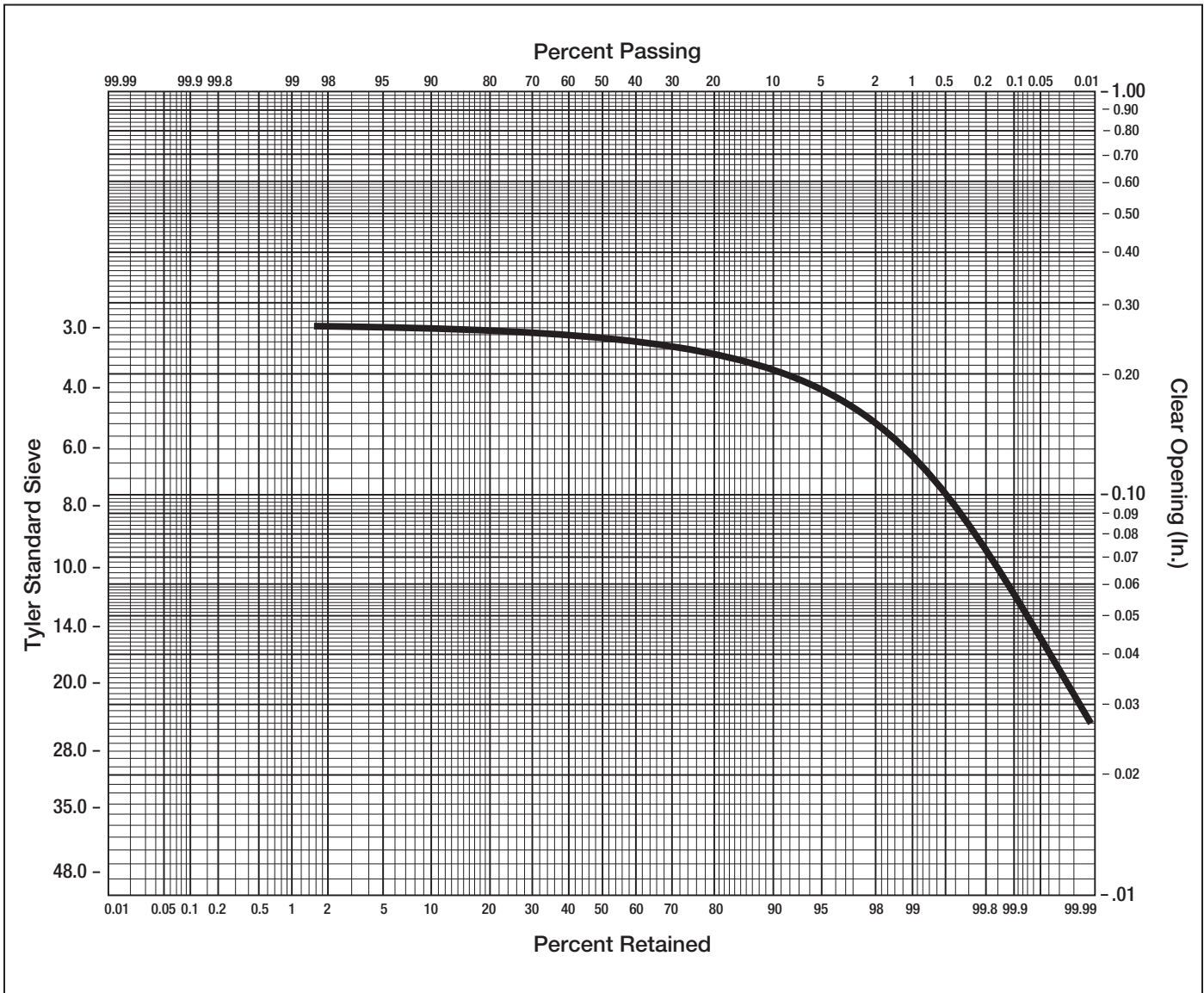

Figure 17: Soybean sample B

Comparing Figs. 16 and 17, the distributions are almost identical up to the point of inflection, at 4 m. Beyond that, the remaining 95% is seen to slope more steeply in A than in B. Of the minus 6m fraction in both samples, the portion passing 14 m. is 17% in Sample A, and only 3% in Sample B. Further investigation revealed that the minus 14 m. fraction in Sample A contained a fine taconite sand typical of the soil in the area where it was grown, and which was absent in Sample A from a different geographic area.

The soybean example shows why empirical formulas for estimating capacity can't be trusted for use with discontinuous size distributions, or separations of less than 10% undersize from continuous distributions. There is no substitute known to this writer for actual experience or scaled testing.

Manufacturers' capacity ratings for screens in grain cleaning applications are based on abundant field experience, but even so, actual F. M. removal efficiencies may range from a low of 25% to a high of 80%, averaging 45 to 60%. Reliable ratings for other granular materials with either discontinuous, or continuous distributions for separations at less than 10% undersize, and D/L ratios greater than 4, should only be derived from prior experience or laboratory testing.

PART 5. FRACTIONAL EFFICIENCY

Screening efficiency is defined as the weight percent of undersize removed in a single-screen separation to the total amount of undersize contained in the feed. It has previously been explained that the probability of passage for an undersize particle of diameter d through an aperture L increases as the square of the difference $(L-d)$. It follows from this relationship that screening efficiency depends on the slope of the distribution curve through the screen aperture. Now if the total size range of the feed is divided into segments of equal intervals on a standard screen scale, for example 20x28, 28x35, 35x48, etc., and the weight of material in each parcel is compared with the weight of the same segment in the screen feed, the result will be the screening efficiency in each segment. This is its Fractional Efficiency.

The relevance of fractional efficiency analysis to an evaluation of the performance characteristics of any sizing device (screen, air, hydraulic) that is less than 100% efficient, is explained this way in a paper by J. P. Vandenhoeck²⁶: "In order to obtain a worthwhile yardstick with which to measure the efficiency of a sizing device which will remain true from one material to another, regardless of cutpoint, product specification, feed gradation, etc., it is necessary to study the efficiency of the device, not at one cutpoint, but at a whole series of cutpoints covering the complete size range of the material being classified"

The procedure outlined by Vandenhoeck, leading to the fractional efficiency (FE) curve plotted on a logarithmic probability grid, starts with a sieve analysis of the oversize and undersize from a single screen separation, in a sieve series covering the complete size range of the feed material. The weight split between oversize and undersize is known from actual or scaled laboratory test. Taking the interval between successive sieves as a size group, the size distribution of the feed is reconstructed from the sum of the fine and coarse fractions in all groups. Then, each group in both oversize and undersize fractions is compared with the same group in the feed, and expressed as a percentage of the feed in that group.

Again quoting Vandenhoeck, "The fractional efficiency is the ratio of material in the oversize or undersize to the material available in that group in the reconstructed feed."

The method is illustrated in the following example. A crushed mineral ore was screened in a laboratory simulation of a full-scale TEXAS SHAKER, equipped with a Tyler standard 12m wire cloth screen with .055" clear opening. The screen retained 38.6% oversize, passing 61.4% through. Sieve analyses of both fractions are plotted on a log-probability grid in Fig. 18.

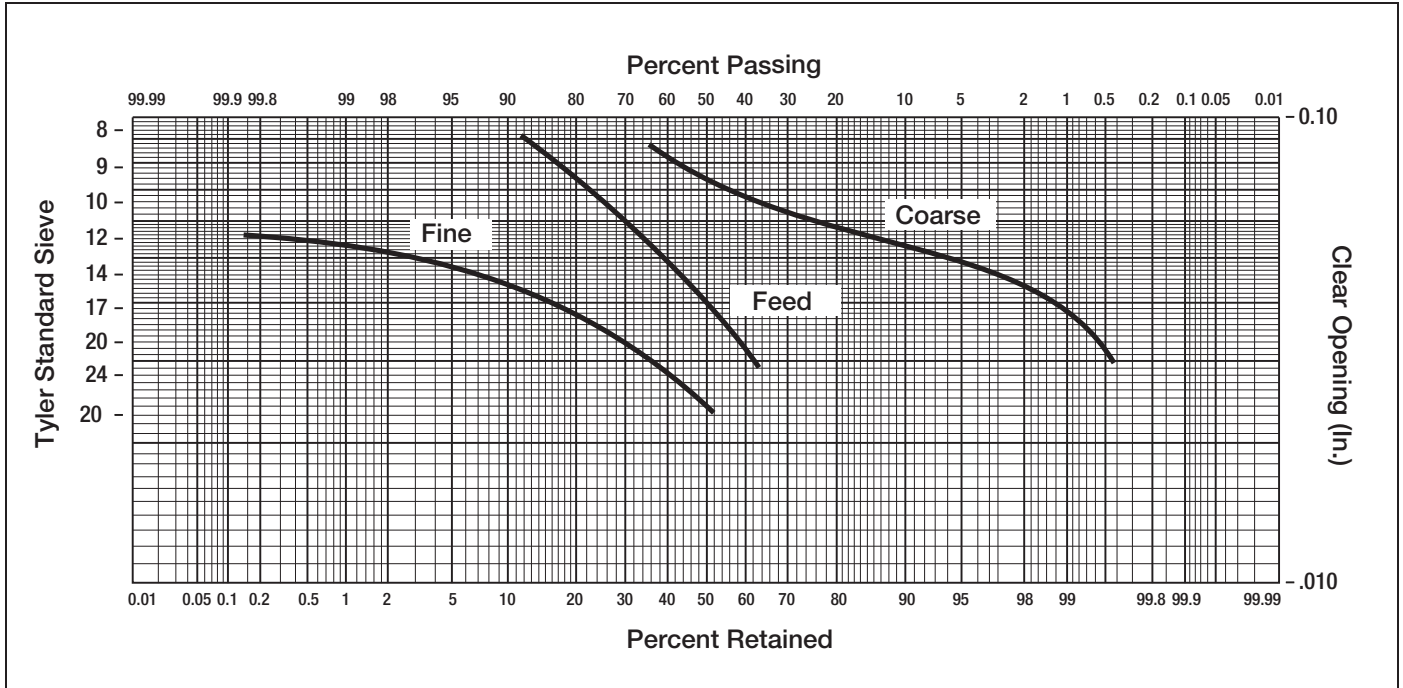

Figure 18: Sieve Analysis for Fractional Efficiency Example

Tyler Std. Sieve	Clear Opening, in.	Overs Distr, %	% Feed in Overs	Throughs Distr, %	% Feed in Throughs	Feed Distr, %	F. E, Overs, %	F. E, Unders, %
9	0.078	43.8	16.9	0.0	0.0	16.9	100.0	0.0
10	0.065	19.8	7.7	0.0	0.0	7.7	100.0	0.0
12	0.055	23.0	8.9	0.3	0.2	9.1	97.8	2.2
14	0.046	10.3	4.0	6.8	4.0	8.0	50.0	50.0
16	0.039	1.9	0.7	10.2	6.3	7.0	10.0	90.0
20	0.0328	0.6	0.2	12.2	7.5	7.7	2.6	97.4
Pan		0.6	0.2	70.5	43.4	43.6	0.5	99.5
Total		100.0	38.6	100.0	61.4	100.0		

Table VI: Fractional Efficiency Calculation; Crushed Mineral Ore Screened On 12 M.
38.6% Overs, 61.4% Unders

The size groups selected for the Fractional Efficiency analysis are found in Table VI as the intervals between sieves 9 and 10, 10 and 12, 12 and 14, 14 and 16, 16 and 20 mesh. The “% Feed in Overs” is calculated as the product of the percent retained in each group and the percent oversize in the feed, and the “% Feed in Unders” is calculated in the same way. The sum of these two numbers in each group is the reconstructed “Feed Distribution %”. The feed analysis, reconstructed as the sum in each size group of the oversize and undersize as percentages of the feed, is also plotted in Fig. 18.

Following these calculations for the group between 12m and 14m, the “% Feed in Overs” is $10.3 \cdot 0.386 = 4.0$. The “% Feed in Unders” is $6.8 \cdot 0.614 = 4.0$. The reconstructed feed is $4\% + 4\% = 8\%$, and the Fractional Efficiency is thus $4 \div 8 \cdot 100 = 50\%$, for both overs and unders. This means the average particle in the size group between 12 and 14 m has an equal probability of being found in either the oversize (coarse) or undersize (fine) fractions. In the group 16 to 20 m., the average particle has only a 2.6% probability of being found in the coarse fraction, and a 97.4% probability of being found in the fine fraction.

The familiar log-probability grid can now be used to plot the Fractional Efficiency for each size group. In Fig. 19, the sieve sizes are shown on the ordinate as before, but the abscissa, which in the size distribution graph was defined as the percent retained or passing, now becomes the probability axis. The Fractional Efficiency of each size group is shown as a vertical line representing its size interval, at the corresponding percent efficiency on the probability axis. The scale at the top of the graph applies to the coarse fraction (overs), and the scale at the bottom applies to the fine fraction (unders).

In the example, in Fig. 19 the lines are drawn for the fractional efficiencies in the 12x10, 14x12, 16x14, and 20x16 groups. A straight line connecting these groups is drawn to intersect as closely as possible the midpoint of each line. This is the Fractional Efficiency (FE) line. The intersection of this line at the 50% probability point is the theoretical cutpoint for the separation. In this example, the intersection is at an opening of about .049”, between 12 and 14 mesh.

The angle of the line with respect to the horizontal (probability) axis is an expression of the separation efficiency of the machine. If the FE line is parallel to the probability axis, all the particles coarser than the theoretical cutpoint are in the coarse fraction, and all the particles finer than the cutpoint are in the fine fraction. The machine efficiency then is 100%. At the other extreme, the FE line overlies the 50% probability line, at right angles to the horizontal axis. Fractional efficiencies are 50% for all size groups, in both fine and coarse fractions, and the screen is simply a sample splitter. Machine separation efficiency is zero. The angle of the line, in the quadrant between zero and 90 deg., can be used to compare the relative separation efficiency of different machine designs, the more efficient having the flatter (smaller angle) FE line.

Note that fractional efficiency, screening efficiency, and machine efficiency are not the same. Fractional efficiency is particular to individual size groups, while screening efficiency encompasses the entire population. In the example, 61.4% of the feed is recovered as minus 12m undersize, but the feed analysis shows 66.3% passing 12 m. Screening efficiency is then $(61.4 \div 66.3) \cdot 100 = 92.6\%$. But if screening efficiency is calculated from the theoretical cutpoint rather than the actual screen aperture, in the present example the undersize recovery of 61.4% matches the percent minus .049”, the theoretical cutpoint, in the feed analysis, and screening efficiency is 100%. Machine efficiency, as the slope of the FE line, is useful only for comparing the relative separation efficiency of different machines.

If screen apertures are changed to increase or decrease the theoretical cutpoint, the FE line will move to intersect the new cutpoint at the 50% probability line, but will be parallel to the first line, provided the slope of the feed size distribution curve remains about the same at the new cutpoint. This will be true for relatively small changes in cutpoint.

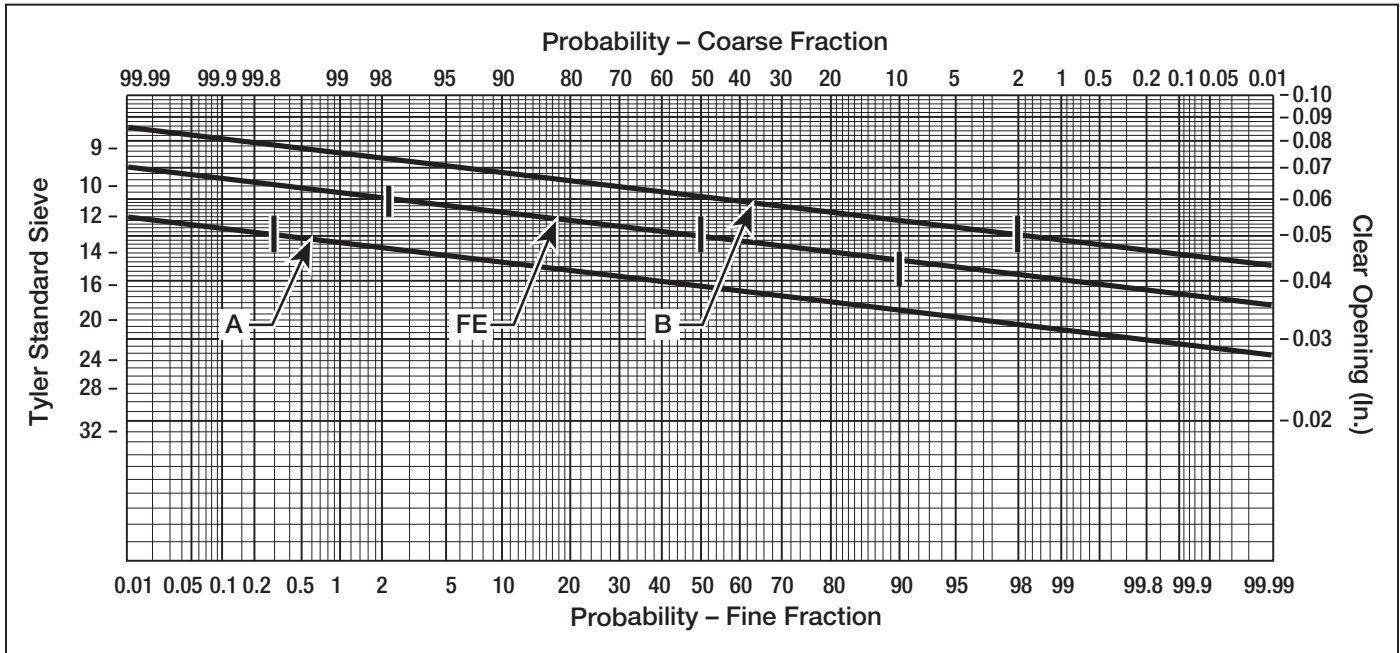

Figure 19: Fractional Efficiency Graph

The Fractional Efficiency graph, constructed from actual test or production results, can be used to guide screen selections in the following way. Referring to Fig. 19 and Table VI, the FE line shows on the lower (unders) scale a 2% probability that particles between about 12m and 10m will be found in the unders from the screen. Now, if a product specification allows only 0.3% plus 12m in the fine (product) fraction, the graph can be used to find the screen size, smaller than the original 12m., needed to comply with this specification. Find the intersection of a horizontal line from 12 m. on the ordinate with the 99.7% line extended from the upper (overs) scale. This will be at the coarse limit of the 12m to 14m. size group, indicated by a line drawn from 12 m. to 14 m. on the 99.7% probability line. Draw a median line "A" from the midpoint of this line parallel to the median line from the test result. The intersection with the 50% probability line for both unders and overs is about 0.038". This is 0.011" less than the first in the example, at .049". It follows that the new screen aperture should be reduced by the same amount from the original .055" Tyler standard, to .044", suggesting a 14m. screen with .028" wire, or 16m. with a .018" wire. Note that this change, while limiting the topsize to conform to the specification, will result in reduced capacity, screening efficiency, or both, if the size distribution of the feed remains the same.

If instead the specification limited the coarse fraction to a maximum of 2% passing 14 m., from the same feed distribution, this places the 12 to 14m size group on the 2% overs-98% unders line. The parallel median line "B" crosses the 50% probability line at .060", compared with the original .049". Adding the .011" difference to the original Tyler 12m. at .055", the new screen could be a 10m. .035" wire or a 10 m, .035" wire.

Referring to the feed distribution curve in Fig.18, if efficiencies remained the same (not likely), the smaller opening in the first case will increase the oversize by about 8%, from 38.6 to 46.6%, while the larger opening in the second case will reduce the oversize by 12%, from 38.6 to 26.6% .

A word of caution, when using the Fractional Efficiency method for adjusting screen apertures: pinpoint accuracy cannot be expected, since it is subject to a variety of sources of error. These can include, in addition to experimental error, the effects of moisture, static electricity, and attraction of coarse for fine particles ranging below 75-50 μ m (about 200 mesh). But if carefully executed, recognizing the possibilities for error, it is superior to guesswork in taking account of the slope of the size distribution curve through the cutpoint.

PART 6. VIBRATION TRANSMISSION

Most modern screening machine designs are based on Newton's Third Law, and accordingly are self-balancing. But they aren't space ships; they do have to stay in the same place, suspended from, or supported on, a stationary structure or foundation.

Spring Suspensions

High speed vibrating screens, either inclined or horizontal, are typically supported on compression springs, which may be steel coil springs, rubber, or pneumatic. Fixed at one end, the other end must follow the motion of the vibrating system. The resistance of the spring to displacement in both vertical and horizontal directions determines the amount and direction of force transmitted through the spring to the supporting foundation or framing. For steel springs, the load/deflection ratio, (spring constant) is linear, directly proportional to deflection. The units of spring stiffness (k) are lb./in. displacement, expressed in the formula

$$k = W / \Delta \quad (7)$$

Where

W = weight supported, lb.

Δ = static deflection, in.

The load supported by each spring is simply the weight of the vibrating system divided by the number of springs in the suspension, while the static deflection is the same weight divided by the total stiffness. The cyclic vertical force transmitted to the supports, F_v , is the total spring stiffness times the vertical displacement component of the motion²⁷:

$$F_v = \Sigma K \cdot S \sin \theta \quad (8)$$

Where

S = Total displacement, (stroke, straight line motion), or (circle dia. circular motion), and

θ = Pitching angle (straight line motion)

This transmitted force will be about the same in the horizontal direction in the case of the inclined vibrating screen. For the horizontal high-speed screen with the same static deflection Δ , the force is multiplied by the sine of the pitching angle for the vertical direction, and by the cosine for the horizontal.

For reasons of stability, steel coil springs are mostly limited to a maximum static deflection of about 3/4 in. Rubber springs like the Firestone Marshmallow[®] 28, having a non-linear load/deflection curve, can offer equivalent static deflections up to about 2" for reduced force transmission. The Firestone Airmount[™]29 is a type of pneumatic spring using Boyle's Law of gas compressibility for linear static deflection equivalents up to 4" 30.

There are some restrictions on stroke, frequency range and ambient temperature for applications of these springs in vibrating equipment. The manufacturer's recommendations should be followed when making substitutions to reduce force transmission.

Cable Suspensions

Because of practical limitations on maximum allowable vertical and transverse displacements of compression springs, shaking or gyratory screening machines with total displacement greater than about 3/4 in. are usually suspended from steel cables or rods. When their motion is confined to the horizontal plane, the cables or rods are connected directly to overhead support framing, with terminals designed to allow for angular movement through the cycle. If the motion includes a significant vertical component, the cables or rods are connected through springs, and the vertical force component is found with the formula (8). The larger component will be horizontal, either straight line for shaking or rotating for gyratory designs, and from the diagram in Fig. 20, can be derived by similar triangles, thus:

$$F_h = \frac{WS}{L} \quad (9)$$

Where

W = Weight of suspended machine, lb.

S = Total (w/w_n) displacement, or stroke, in.

L = Length of suspension cable (or rod), in.

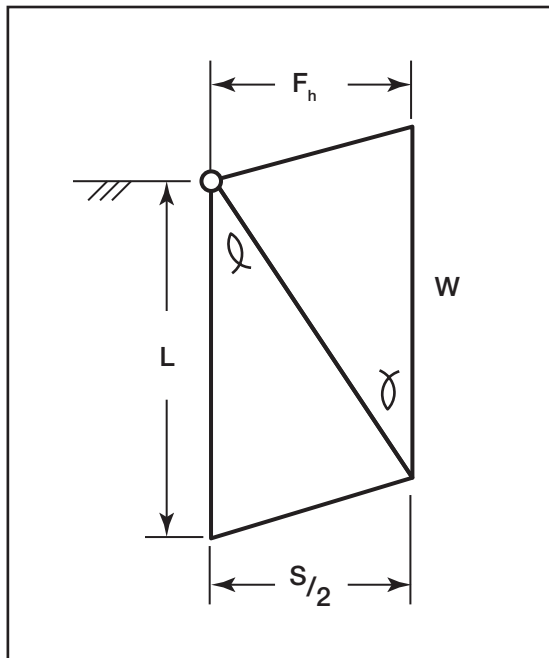

It will be noted that this horizontal force component is independent of frequency or inertia force³¹. If the applied force is horizontal, the cyclic lifting force is negligible. The horizontal force, inversely proportional to the length of the suspension cable, may or may not be inconsequential in a steel-framed building.

Figure 20: Horizontal Force Transmission in Cable or Rod Suspensions

Vibration In Steel-Framed Industrial Structures

The effect of vibration transmission from vibrating equipment can be magnified to uncomfortable or possibly dangerous levels by resonance, a natural phenomenon in which, if the frequency of the disturbing force is very close to the natural frequency of the system, the amplitude of vibration of the system is very large.

In new construction, benefitting from modern structural design practice, FEA analysis can provide a safeguard if the magnitude, direction and frequency of these forces is known to the designer (as they should be).

But in retrofitting new equipment into existing structures, or if FEA methods are impractical or unavailable, most problems with resonance can be avoided by observing a few simple rules that govern the behavior of single structural elements.

The natural frequency of a pendulum, applying to cable suspension, is expressed in the formula

$$\omega_n = 188 \sqrt{1/L} \quad (10)$$

Where

ω_n = Natural frequency, cycles/min;

L = Free length of cable, in.

The natural frequency of any beam, supported at its ends, is the same, with static deflection Δ (in.) substituted for L .

If a beam is loaded only by its own weight, its natural frequency can be calculated from the formula

$$\omega_n = \frac{K}{L^2} \sqrt{\frac{EI}{W}} \quad (11)$$

Where

K = Constant determined by end conditions, i. e.,

Ends Clamped 88.6

Ends supported....39.6;

L = Length of beam, ft.;

E = Elastic modulus (for steel, 30E6psi);

I = Moment of inertia of beam about its neutral axis, in⁴;

W = Unit weight of beam, lb/ft.

Calculation of stresses due to deflection must take into account the weight and position of the vibrating system (equipment), in addition to the weight of the beam and the transmitted dynamic forces. The static deflection due to the sprung weight of the equipment is neglected in calculating the natural frequency of the supporting beam; however, if concentrated unsprung loads such as hoppers with their contents, other machines, etc. are supported by the beam, the natural frequency of the beam will be proportional to the square root of the reciprocal of the sum of static deflections due to each separate load plus the deflection of the beam, from the formula

$$\omega_n = 188 \cdot \sqrt{\frac{1}{\Delta_1 + \Delta_2 + \Delta_3 + \dots \Delta_n}} \quad (12)$$

The static deflection of the beam under its own weight can be calculated from the previously determined natural frequency, as

$$\Delta = \left(\frac{188}{\omega_n} \right)^2 \quad (13)$$

The horizontal force component transmitted through the springs is transferred to the columns supporting the beam. The resulting horizontal displacement is dependent on the elastic behavior of the whole structure, not easily calculated except by FEA methods. The physiological effects on operating personnel of the vertical vibrations (displacements) of the beam are usually of more immediate concern to the designer. The vibration amplitude X (half the total deflection, not to be confused with its static deflection) is a function of the ratio of the forcing frequency ω to the natural frequency of the beam, ω_n . When damping is negligible, X (for values of $\omega/\omega_n \geq 1$) can be calculated from the formula.³²

$$X / X_0 = 1 / \{ (\omega/\omega_n)^2 - 1 \} \quad (14)$$

Where

X_0 = Zero frequency deflection of the beam under the action of the peak vertical force applied through the suspension springs, and

X/X_0 is the Magnification Factor, by which X_0 must be multiplied to obtain the amplitude X at any frequency ratio.

At resonance, when $\omega/\omega_n = 1$, the amplitude X can increase, at zero damping, without limit. As the frequency ratio is increased to $\sqrt{2}$, X becomes equal to X_0 . As the ratio increases further to 3:1, the amplitude X diminishes to 1/8 of X_0 . On the other side of resonance, if the stiffness of the supporting member is increased to frequency ratios ≤ 1 , amplitude X will decrease rapidly from the resonant condition {for example, to $1.33X_0$ at $\omega/\omega_n = 0.5$ }. As ω_n is increased further, approaching zero, the Magnification Factor will approach unity as a minimum.

The purpose of the isolation system is to minimize the forces transmitted to the building structure. Vertical vibrations in the screen support framing, transmitted to the floor, are necessarily limited by design to amplitudes and frequencies that can be tolerated by the average human being. Stresses resulting from transmitted omnidirectional vibrations, superimposed on stresses due to static loading, can cause fatigue failures in structural connections.

When a vibrating screen is to be installed in a new or existing steel structure, the designer needs to know its weight and the magnitude, frequency, direction and position(s) of the transmitted forces that will be applied to the primary support members. This information should be provided by the equipment manufacturer. It is then the designer's responsibility to use this information in designing a structure that will meet criteria set by the Owner's specifications (if any) limiting allowable vibration amplitudes.

Formula 14 is a useful guide to allowable frequency ratios (ω/ω_n). Obviously, unity is a "no-go", but which side to come down on is an engineering decision based on the disturbing frequency and allowable structural stresses. As a general rule, consider excluding any structural or mechanical frequency ratio in the range between 0.8 and 1.2. At these limits, the magnification ratios are 2.7 and 2.3, respectively.

Cyclic forces applied at any point in a steel-framed building, if not fully absorbed by damping, can be transmitted to secondary bracing members and attachments such as piping, rigid conduit, lighting fixtures, etc. Excessive amplitudes due to resonance with the disturbing frequency are most easily suppressed with bracing to reduce the frequency ratio (ω/ω_n). When increasing the natural frequency of any structural section, it's useful to note, from Formula 11, that stiffening by reducing length is more effective than increasing section properties (I/W) in the same proportions.

PART 7. MECHANICAL DESIGN

Drive Mechanisms

The various kinds of motion employed in screening machines are described in a previous section. Most modern commercial designs employ either circular or straight-line reciprocating motion. Governed by Newton's second and third Laws of Motion, they (excluding the rare electromagnetic or ultrasonic designs) develop their driving force from the rotation of unbalanced weights, mounted in anti-friction bearings. The load on the bearings is a constant, proportional to the live (vibrating) weight times the amplitude of the motion and the square of the rpm, according to the simplified formula

$$P(\text{lb}) = 1.42W \cdot S \cdot N^2 E^{-5} \quad (15)$$

Where:

W = Total weight of moving parts, lb;

S = Total stroke, in. for reciprocating motion, or circle dia. for rotary or gyratory.

N = RPM (rev./min)

The centrifugal force P applied to the moving structure is constant for circular motion in any plane, and periodic for reciprocation in any linear direction. Only one unbalanced rotor is needed for circular motion, but two rotors, with their unbalances 180° opposed, and turning in opposite directions, are needed to generate a straight-line reciprocating motion. In both cases, the bearings through which the force is applied are mounted on, and move with, the machine structure to which they are attached. The weight of the unbalances is thus a part of the total moving weight W in the formula 15.

The selection and sizing of the bearings is an important indicator of overall quality, and is fundamental to the serviceability of the screening machine. That is why a buyer's RFQ specifications commonly include a "Minimum B-10 (or L-10) Life" for the bearings. That number represents one-fifth of the predicted average hours to failure of 90% of the individuals in a statistical universe, under defined conditions of lubrication, loading, and rpm. But the typical RFQ overlooks the huge influences of rpm and loading in the empirical formula for the B-10 calculation, leaving the bidder free to manipulate the calculation to satisfy the requirement. The unspoken reality is that the term "B-10 Life" can mean, Humpty-Dumpty-like, whatever the responder chooses it to mean. This can be appreciated by an examination of the NAFBM-approved empirical formula for the B-10 life of a bearing supporting any rotating unbalance:

$$B10 \text{ Life} = 0.23 \cdot \{ (BDC \times N \div Wr \times af)^{3.33} \div RPM^{7.66} \} E20 \quad (16)$$

Where

BDC = The bearing manufacturer's Basic Dynamic Capacity rating, in lb;

Wr = Dynamic loading of the bearing, in terms of the weight *W* (lb) of the rotating unbalance times the moment arm *r* (in.) from the center of rotation to the center of gravity of the weight;

N = Number of bearings supporting each rotor;

af = Application Factor, a dimensionless number usually suggested by the manufacturer.

RPM = Obviously, revolutions per minute.

The relative influence on bearing life of the rotating unbalance (*Wr*) and RPM is shown graphically in Fig. 21. Since the stroke *S* of the vibrating system is proportional to the *Wr* of the rotating weight, it can be seen from formula 16 that a 10% increase in stroke will shorten the B10 life by about 27%, and a 10% increase in RPM cuts it by 52%. However, formula 15 shows that a 10% increase in peak acceleration (*g*), if gained by a corresponding change in *Wr*, will reduce bearing life by the same 27%, but if the stroke is kept constant and only the RPM is changed, the reduction in bearing life for the same increase to 1.1•*g* will be about the same, at 31% ($1 - 1/1.1^{3.83}$)

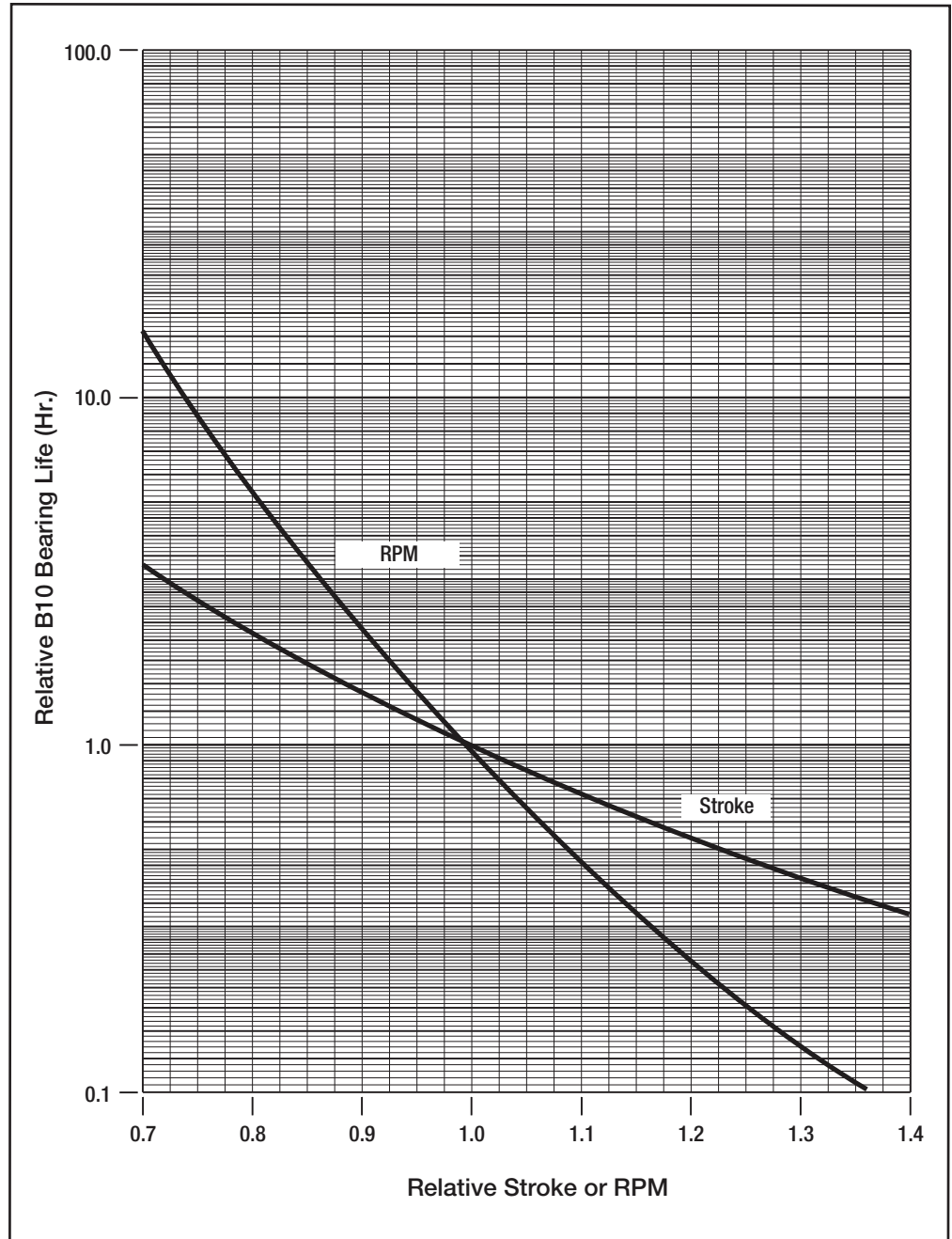

Figure 21: Effect on Relative Bearing Life of Changes in RPM and Stroke

The user of any vibrating screen of the types described here should be aware of the consequences of changing, in pursuit of improved capacity, efficiency, or blinding resistance, either speed (*RPM*) or stroke (*S*) from the original factory settings. The specification writer or purchaser should know that the mere statement of “B10” life is meaningless unless defined by speed (*RPM*), stroke (*S*), vibrating weight (*W*), and application factor (*Af*). And that assumes that the manufacturer’s Basic Dynamic Capacity (*BDC*) rating can be trusted.

The ultimate bearing life of five times B-10, at the inception of fatigue spalling, is rarely, if ever, realized in practice. Probable life expectancy depends first on the design of the bearing installation and the degree of protection it provides against contamination, a common cause of premature failure. Contamination can be introduced with the lubricant, or from the environment in the form of atmospheric dust and moisture. If the lubricant is grease, replenishment can be too much or too little. Oil, in circulating systems or bath, is desirable for the larger bearing sizes and higher speeds, but can be susceptible to seal leakage. Despite the claims of manufacturers, there’s no rose without a thorn, and no substitute for meticulous attention to lubrication. On-site replacements of failed bearings often set the stage for premature failure, caused by contamination, unrepaired wear, or damage to housing bores and bearing journals.

Structures

Screening requires some kind of circular, vibrating or shaking motion, which is imparted to the structure supporting the screening surface by forces generated in the vibrating mechanism. In modern designs, the mechanism becomes an integral part of the vibrating structure. Obeying Newton’s Third Law, the generating and reacting forces are equal and opposite, and thus the vibrating system is self-balancing.

The common structure supporting the vibrating mechanism and the screen surface is subjected to the inertia forces causing the motion. The resulting stresses in the structure, are constant, horizontal, and omni-directional in gyratory or circle-throw designs. In vibrating and shaking screens the forces are cyclic, linear, and have both vertical and horizontal components. According to Newton’s Second Law, the force required to produce the motion is proportional to the product of the weight of the vibrating system, and its acceleration³³ This means that the design of the system is necessarily a compromise between weight, strength and stiffness.

Ranking second to life-limiting mechanical failures in the vibrating mechanism is fatigue cracking within the structure. This will occur at points of stress concentration in a primary load path, or a branch. The point of origin can be a weld, an abrupt change in section, or an accidental or intentional notch.

The probabilities for fatigue cracking in screening machines as they age can never be reduced to zero. But if a crack is detected before it has progressed to structural failure, most can be successfully repaired on-site³⁴. There is no one-size-fits-all repair technique known to this writer, so for a successful long-term repair it’s advisable to first consult the manufacturer (who should know what to do).

PART 8. INSTALLATION PLANNING

Whether the new screening machine is to be installed in a new facility or in an existing process, advance planning is essential to a successful result in terms of cost, safety, and maintainability.

Structure

No special foundation is needed for vibrating or oscillating screens of modern balanced design, if they are installed on ground level reinforced concrete floors suitable for industrial buildings. Above ground installations in steel-framed buildings, however, are subject to the effects of transmitted vibration from cyclic forces which, although small, can be magnified through resonance, as described in the previous section on Vibration Transmission. With information supplied by the manufacturer on the locations, magnitudes, and frequencies of the transmitted forces, the supporting structure can be designed to minimize vibrations of primary and secondary structural members and non-structural attachments.

Clearances, Platforms and Catwalks

A good installation provides ample working space around and above the machine.

A 30 in. minimum clearance allows convenient access for inspection and some routine maintenance. The manufacturer should be consulted about the most advantageous placement of catwalks and platforms. OSHA regulations call for guard rails and toeboards around catwalks and platforms more than 48 in. above the nearest floor level, and 18 in. minimum clearance from guard rails to machine.

In most modern screen designs, screen cloth may be side tensioned and stretched over a crowned deck frame (high speed vibrating screens), or attached to a flat frame (oscillating or gyratory screens). Removal requires a frontal clearance equal to half or all of the active screen length. This minimum clearance should be specified in the manufacturer's certified drawings.

Vibrator mechanisms may be either built in to the structure of the machine, or enclosed in a separate module attached to the structure. In the former case, provision must be made in the installation plan for clearances and access needed for on-site repair and parts replacement. The separate module can either be repaired on-site, or replaced with a spare, and moved to the shop for repair or rebuilding under conditions more favorable to a successful result. A good installation plan will exploit this advantage by providing space for handling and transit. The manufacturer, or his distributor, should be asked for recommendations.

Feed to the Screen

Any screening machine will perform at its best with a steady constant-rate feed. This condition is satisfied in typical dry bulk material handling systems, the process starting with a surge bin and feeder that can deliver a steady flow at the desired throughput. Delivery to the screen may be via belt or screw conveyor, or bucket elevator. The feed stream is usually concentrated into a cross-section of fairly narrow width. This concentrated stream has to be quickly expanded to the full width of the screen surface.

Gyratory screens, whether rectangular or round, make this expansion with their circular motion. The crowned, side-tensioned screen surface in high-speed vibrating screens, either inclined or horizontal, helps with distribution, but up to 20% of active screen surface may be lost if not assisted by an initial spread in the screen inlet. Straight-line reciprocating flat screens, or “shakers”, can lose up to half of their screen surface without the assistance of an upstream spreader.

Feed spreaders may be either dynamic, in which the material flow is not interrupted, or static. In the latter, a surge bin interrupts the flow, and discharges a continuous full-width stream.³⁵

Flexible Connections

Some screening machines are fully enclosed. Others (most vibrating screens) offer a choice of open or enclosed construction. Enclosures are usually integral with the vibrating

structure, requiring flexible connections or “boots” between the moving inlet or outlet(s) and the stationary feed and discharge chutes. The boots are supplied for the connection to the machine, but it is left to the installation designer to match the boots to the stationary chutes. In doing so, he must allow at the interfaces ample clearance (should be specified by the manufacturer) to avoid physical interference at maximum vertical and horizontal displacement limits. The suggested designs shown in Fig. 22 for feed and discharge connections comprise an inner abrasion-resistant rubber sleeve attached at one end only, and an outer dust jacket attached at both ends. There are no internal ledges to trap “pockets” of material, that could rub against the dust jacket, at its downstream attachment. The dust jacket must be long enough to avoid stretching at the maximum displacement limits.

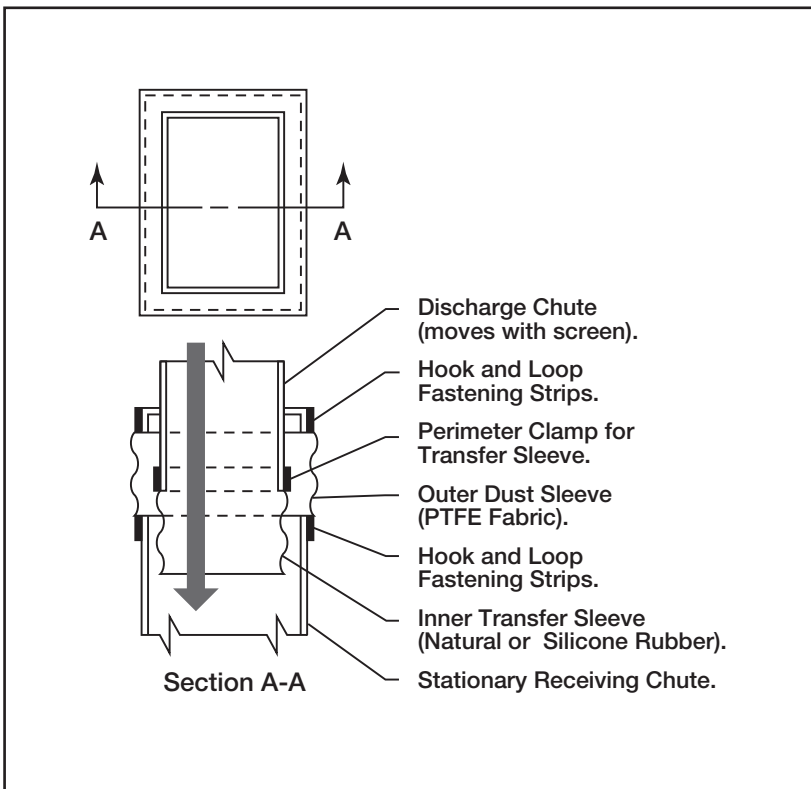

Figure 22: Suggested Flexible Boot Design for Stationary to Moving Interfaces

Feed inlets and discharge outlets may be either round, elliptical, or rectangular. Round or elliptical connections are easily made with various types of band clamps, or hook-and-loop (“Velcro”) tapes. Hook-and-loop connections are most convenient for rectangular connections, and have proved to be very secure if correctly designed.

A good boot design and installation will make life easier for operating and maintenance personnel. The manufacturer’s General Arrangement drawings should include, for approval by the purchaser, details showing the boots to be furnished and how to connect them to his matching stationary feed and discharge chutes.

Dust Control

Enclosures are designed for dust containment from infeed to discharge. As the dust is generated, it needs a place to go, or else it will build up on internal surfaces, to eventually contaminate the separated fractions. This calls for a dust control system which, by maintaining a slight negative pressure in the enclosure, entrains the initially airborne dust in an exhaust air stream that may be independent, or a branch of a central plant dust control system.

There is a well-known risk, notably in grain handling facilities, of fire and explosion from concentrations of organic dusts in confined spaces. To mitigate this risk, the National Fire Prevention Association, in Code 69 B for grain elevators, recommends for all enclosed screening machines an exhaust flow volume of 50 CFM per square foot of projected screen area. Thus, for an enclosed machine with active screen dimensions 5’ x 10’, the recommended exhaust flow is 2,500 CFM, regardless of the number of parallel screen decks enclosed.

To facilitate compliance with this code, the screen manufacturer should provide an exhaust connection designed to induce an airflow distributed well enough to entrain airborne dust and carry it to an outlet transition sized for a velocity of 3,500-4,000 fpm. This transition may be located anywhere in the enclosure where there is no risk of entrainment of product fines. It is then up to the buyer to decide whether or not to make use of the connection.

This ventilation for dust control is not to be confused with “aspiration”, whose purpose is to separate from the product, before or after screening, a light fraction that is differentiated from the product by terminal velocity in air, rather than size. Screening and aspiration are two different operations, that may be, but seldom are, combined in a single unit.

PART 9. PREVENTIVE MAINTENANCE

Instructions for installation and routine maintenance are covered in the Manuals provided with new screening machines of all types. The suggestions in this Section are intended to prevent unexpected failures, not to supersede the manufacturer's instructions, in the event of conflict. Unexpected failures presaging unscheduled shutdowns in screening machines are most likely to occur in any of three principal components: structure, vibrating mechanism, or screen cloth.

Structure

Vibrating or shaking screens are vulnerable to fatigue failures caused by the cyclic forces applied to the entire structure. Fatigue fractures in gyratory and circle-throw screens, subjected mainly to a constant rotating centrifugal force in the horizontal plane, are confined to the structure that transfers the load from the bearings to the screen box.

Fatigue failures start with a crack initiated at a stress concentration in a welded intersection, the end of a weld run, or an abrupt change in section (stiffness). The crack usually propagates slowly at first, the rate of growth increasing as the crack grows longer. If unchecked, it will travel along grain boundaries, the average stress in the sound material ahead of the crack increasing toward ultimate fracture.

Fatigue cracks in plates may grow to a length of several inches before detection. Cracks in external surfaces are easily seen by close visual inspection. Cracks in concealed structures can escape detection until a fracture results, evidenced by unusual rattles or knocking sounds. Any unusual sounds are cause for an immediate shutdown and inspection to find the source. When discovered, the immediate (temporary) remedy is to find exactly the end(s) of the crack (and its branches, if any) using a dye check if necessary, and drill a hole there as a crack arrestor to prevent further growth.

If the crack is in a weld, either along a toe or in the root, it can be ground out through the root completely to the ends and re-welded, using the precautions essential to good welding practice³⁶. In an emergency, if necessary to keep the machine running, a tension strap can be positioned to cross the crack at right angles, forming a bridge across the crack, and welded around the ends. The welds should not be continuous and should not intersect the crack. Otherwise, improvised patching and welding over a stop-drilled crack is not recommended, as it may interfere with permanent repairs.

Hastily improvised and executed field remedies often have a short life expectancy, and can start cracks from unintended new stress concentrations. When fatigue cracks or fractures are detected or suspected, immediate consultation with the manufacturer on the best long-term repair techniques is advised.

Vibrating Mechanisms

Vibrating mechanisms may be mechanical, pneumatic, or electromagnetic. The latter two are always packaged modular units, which can be quickly replaced when they malfunction.

Mechanical vibrators, whether integral with the structure or externally mounted modules, comprise one or more rotating shafts mounted in anti-friction bearings. Impending failures almost always are signaled by the gradual development of noise and/ or vibration in one or more bearings. Both are symptoms of fatigue spalling, or pitting, in the bearing races and/or rollers. If neglected, these symptoms will invariably lead to an eventual seizure within the bearing.

The only remedy is to replace the bearing, after a thorough investigation to isolate the cause of the failure³⁷.

If the two parallel rotors in a vibrator unit are gear-coupled, the gears normally will generate some noise, but without vibration. Excessive backlash in the gearset, or damage from lubricant contamination with foreign material, may result in an increasing noise level, but with little or no vibration.

A few simple rules can reduce the probability for premature bearing failure in well-designed mechanisms:

For grease lubrication:

1. Observe the manufacturer's recommended intervals for grease replenishment and replacement, and don't overgrease.
2. Open purge ports (if provided) when adding grease, to expel old grease from the bearing housing.
3. Wipe grease fittings clean before connecting the grease gun.
4. Guard against contamination of grease supplies with moisture or foreign material.

For oil lubrication:

1. Maintain the oil level within the manufacturers' recommended limits;
2. Use the manufacturers' recommended oil, or approved substitutes;
3. Use a strainer to guard against introducing contamination when adding makeup or changing oil.
4. When changing oil at the manufacturers' recommended intervals, drain while the oil is hot. Clean magnetic drain plugs, if provided.
5. Inspect vent filters periodically, more often in very dusty environments, and replace when clogged. Don't substitute automotive oil filters.

If symptoms of impending failure are detected:

Follow the manufacturer's instructions when repairing or rebuilding vibrator mechanisms. Whenever possible, move enclosed vibrator modules to a clean shop environment before opening up the enclosure. For best results, send the module to the factory for rebuild, and replace with a spare.

Screening Media

Screening machines can be fitted with a variety of media, as explained in a previous section (see note 10). Woven wire, profile bars, perforated plate, polyurethane and rubber are available options. Because it is a consumption item, the choice is governed by cost, aperture size and shape, expected life (wear resistance), and efficiency (percent open area), not necessarily in that order.

Woven wire cloth is usually the most efficient, in terms of capacity per unit area, and lowest cost, hence the most commonly used. Wire cloth openings range from .0015" up to 4", in wire diameters as fine as .0012" increasing to 1". An almost infinite range of combinations and permutations of openings and wire diameters allows the user to balance ruggedness (coarser wire) with percent open area (finer wire).

Screen cloth is subject both to impact and abrasive wear from material passing over the surface and through the openings. There is no empirical formula for life expectancy. As a general rule, coarse screens with larger wires last longer than fine screens with smaller wires. Within that rubric, the objective of preventive maintenance is to forestall premature failures before the screen wears out from normal impact and abrasion.

Screen cloth in high-speed vibrating screens, both horizontal and inclined, is typically stretched taut across the width of the screen deck, slightly crowned over rubber-cushioned longitudinal rails. Tension bars engage formed hooks along the edges parallel to the rails, reinforced in various ways for wire diameters below 3/8". Tension is applied with bolts or other devices, with threaded bolts being the most common.

Assuming that the screen cloth is correctly specified and manufactured, and the screen support deck is designed with the correct camber (crown), the principle cause of premature failure will be over-or-under tensioning. Too much tension can overstress the transverse (shoot) wires carrying the tension load; too little will allow the screen to flutter over the support rails, leading to fatigue failure, usually along the edges of reinforced hook strips, in the shoot wires carrying the tension.

The tension in these wires is a function of the tension bolt torque, averaged over the number of wires and their cross-section area. The allowable tension is limited by the tensile strength of the wire material. Theoretically there could be a formula for calculating the allowable bolt torque based on material properties, wire diameter and

number of wires per unit length, but it would be of dubious value because of errors due to variances in uniformity, camber and friction. As a practical matter, correct tensioning is the responsibility of the operator who installs and periodically inspects the screen cloth, and has learned by experience.

Gyratory and shaking screens, having a negligible vertical motion component, are typically equipped with flat screens, pre-stretched on frames. After the screen cloth is mounted on the frame, there is nothing left to the judgment of the operator, except to make sure that the screen frames are secured tightly in their mountings.

Disposable screen frames with factory-mounted screens can be purchased from some manufacturers or in some cases from screen cloth vendors, but the user may prefer to buy the screen cloth in bulk and mount it in-house. In mounting the screen, tensioning is required to smooth out wrinkles only in fine-mesh screens. Various mounting techniques, using rivets, tacks or adhesives, are prescribed by the manufacturers³⁸.

NOTES

1. J. M. Dalla Valle, "Micromeritics", p.108, Pitman Publishing 1948
2. "Elements of Ore Dressing", Arthur F. Taggart, p. 18, Wiley 1951
3. See Dalla Valle, 1-7, for a description of sieving motions and their relative effects on efficiency.
4. Excluded from these four categories, because they don't share any of their characteristics, are special types including disc screens, rotary screens (trommels) and "sieve bend" static dewatering screens, (also known as "DSM" after the original user, Dutch States Mines). Disc screens and trommels are described in <http://www.sssdynamics.com/docs/white-papers/the-place-of-the-trommel-in-resource-recovery.pdf>. They are used for coarse screening in solid waste classification, taking advantage of their tumbling action with bulky, wet oversize. For a description of the sieve bend static screen and its uses, see P. L. Stavenger, "SME Minerals Processing Handbook", Society of Mining Engineers 1985, pp. 19-25.
5. SME Minerals Processing Handbook", pp 3E2-3
6. For instance, "Mechanical Conveyors", Appendix D, Fayed & Skocir, Technomic Publishing Company, 1997
7. Dalla Valle, "Micromeritics", Table 11, page 97.
8. Section 5, Fractional Efficiency, pp. 29-34
9. Section 4, Capacity Estimating Method, pp. 20-29
10. See C. W. Matthews, "Screening Media", Section 4, SME Mineral Processing Handbook, SE 25-41
11. The mechanics of this system, commonly used in vibrating conveyors, are explained in an ASME reprint available at <http://www.sssdynamics.com/docs/white-papers/the-vibrating-conveyor-for-incinerator-ash-handling-systems.pdf> accessed Sept. 7, 2012
12. A multiple of the acceleration due to gravity (1g)
13. Dalle Valle, op. cit., pp 104-109
14. See Matthews, op. cit., Table 7, p. 3E13, for typical stroke/rpm combinations for various separation sizes in circle-throw inclined screens.
15. K. G. Colman, SME Mineral Processing Handbook, p. 3E-17, Society of Mining Engineers, 1985
16. $C = 2.636 L^{0.617}$
17. $K_1 = 0.404e^{0.0192x}$, where X = Percent in feed half size to aperture width
18. $K_7 = 0.9$ to $D/L=4$, then $1.572 e^{-(0.1272 D/L)}$
19. Adapted from Table 5, Simplified Practice Bulletin R163-36, "Coarse Aggregates", published by Bureau of Standards, United States Department of Commerce
20. C R Matthews, Chart F, SME Mineral Processing Handbook, Section 3E-11
21. Adapted from K. G. Colman, Table II, SME Mineral Processing Handbook, Section 3E-48

-
22. $C_f \text{ (lb/hr/passing/ft}^2\text{)} = 15,507 L^{0.8454}$
 23. $A = 0.5e^{0.01391X}$, where X = Percent in feed half-size to screen aperture.
 24. $F = 1.33 [\log (L/t) + .4604]$
 25. $G = 2.354 X^{-(0.257)}$, where X = Percent in feed between aperture and half-size.
 26. J P Vandenhoeck, "Effects of Sizing Equipment Efficiency on Product Gradation and Weight Splits", Preprint #65B28, Society of Mining Engineers, 1965.
 27. Absent magnification due to resonance, the amplitude of the vibrating system is in direct proportion to the Wr of the rotating weights, where W is the rotating weight and r is the distance from the center of rotation to the centroid of the weight. Thus, if the rotating weight is 100 lb, and r is 4", and the total weight of the system is 2000 lb, its amplitude $S/2$ will be $100 \times 4/2000 = 0.2$. To avoid significant magnification of the transmitted force, the ratio of the vibration frequency (rpm) to the natural frequency of the suspension ($\omega_n = 188\sqrt{\frac{1}{L}}$) should be held above 3:1.
 28. See MMDM-A4 703 for applications of the Marshmellow® Rubber Spring in vibrating equipment.
 29. See Firestone Catalog MASAM 203 for details on the Firestone Airmount™ spring.
 30. Triple/S Dynamics Screening Technology Handbook, 1972, p. 72, footnote #1.
 31. Because of the low natural frequency of the pendulum ($\omega_n = 188\sqrt{\frac{1}{L}}$), where L is in inches, magnification due to resonance is insignificant.
 32. See W. T. Thompson, Chapter 4, "Mechanical Vibrations", Prentice-Hall 1953, for the derivation of Formula (14). For values of $\omega/\omega_n \leq 1$, reverse the signs in the denominator.
 33. Acceleration, in harmonic motion, is directly proportional to the square of the frequency ω and the first power of amplitude ($S/2$)
 34. Techniques for on-site repair of fatigue cracks are discussed in Section 8, Preventive Maintenance", pages 45 – 46.
 35. "How to Feed the TEXAS SHAKER", <http://www.sssdynamics.com/literature.pdf>, accessed Aug. 17 2013
 36. Weld repairs should be attempted only on mild or HSLA steels, with less than .02 carbon. Use only E7018 coated electrodes, from a freshly opened package. Make sure that surfaces are dry by heating with a rosebud-tip oxyactylene torch to 250-300 deg. F. Use a disc grinder to clean edges for fillet welds, or to grind a bevel on cracks before filling. Use a chipper to remove slag between passes in multi-pass welds. Max. temp. between passes 250 deg. F. For further information, see AWS Structural Welding Code D1.1/D1.1M:2010, Section 5, pages 179-198.
 37. A well-illustrated discussion of anti-friction bearing failures and their causes can be found in an SKF publication "Product Information 401".
 38. J. D. White, "How to Install Screen Cloth on a Flat Screen Frame", <http://www.sssdynamics.com/literature.pdf>, accessed Jan. 4, 2013.

BIBLIOGRAPHY

SME Mineral Processing Handbook. 1981. "Screening", pp. 3E1-45.

Thomson, W. T. Mechanical Vibrations. New York: Prentice-Hall. 1953.

The Tyler Wire Cloth Handbook. Catalog 74, 1998 Edition.

VSMA Vibrating Screen Handbook. CIMA, Milwaukee.

Dallavalle, J. M. "Micromeritics: The Technology of Fine Particles". New York: Pitman 1948.

Taggart, Arthur F. "Elements of Ore Dressing". New York: John Wiley & Sons 1951.

Vandenhoeck, J. P. "Effects of Sizing Equipment Efficiency on Product Gradation and Weight Splits". Society of Mining Engineers, 1965.

American Welding Society Structural Welding Code D1.1/D1.1M. 2010. Section 5. pp. 179-178.

Fayed, Mohammed E. et al. Mechanical Conveyors: Selection and Operation. Lancaster: Technomic Publications. 1997.

Sullivan, J. F. "Resonant Screens for the Mining Industry". Mining Congress Journal. (September 1962).

Sullivan, J. F. "What the Western Contractor Should Know About Aggregate Screens and Screening" Western Construction. (1961).

Sullivan, Jeffrey et. al., "The Place of the Trommel in Resource Recovery" ASME, Proceedings of National Waste Processing Conference. Book No. 100328 – 1992.

"Screening Solutions" International Mining. February 2011: 70-79.

Sullivan, J. F. et al, "The Vibrating Conveyor for Incinerator Ash Handling Systems" ASME National Waste Processing Conference. Book No. 100301 – 19